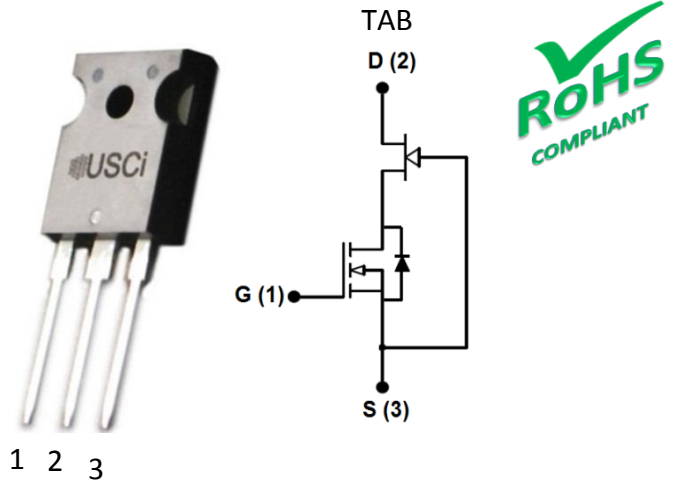


### Features

- Low On-Resistance  $R_{DS(on)max}$  of 0.045 Ohm
- Voltage controlled
- Maximum operating temperature of 150°C
- Extremely fast switching not dependent on temperature
- Low gate charge
- Low intrinsic capacitance
- RoHS compliant

### Typical Applications

- Over Current Protection Circuits
- DC-AC Inverters
- Switch Mode Power Supplies
- Power Factor Correction Modules
- Motor Drives
- Induction Heating



Part Number	Package	Marking
<b>UJC06505K</b>	<b>TO-247</b>	<b>UJC06505K</b>

### Descriptions

United Silicon Carbide, Inc offers the **xJ series** of high-performance SiC cascode switches. This series exhibits ultra-low on resistance ( $R_{DS(ON)}$ ) and gate charge ( $Q_g$ ) allowing for low conduction and switching loss.

### Maximum Ratings

Parameter	Symbol	Test Conditions	Value	Units
Drain-Source Voltage	$V_{DS}$		650	V
Gate-Source Voltage	$V_{GS}$	DC	-20 to +20	V
Continuous Drain Current	$I_D$	$T_C = 25^\circ\text{C}$	36.5	A
Continuous Drain Current	$I_D$	$T_C = 100^\circ\text{C}$	23.5	A
Pulsed Drain Current	$I_{DM}$	$T_j = 25^\circ\text{C}$	113	A
		$T_j = 150^\circ\text{C}$	78	
Short-Circuit Withstand Time <sup>1</sup>	$t_{SC}$	$V_{GS}=15\text{V}, V_{CC}<300\text{V}$	4	$\mu\text{s}$
Single Pulsed Avalanche Energy <sup>1</sup>	$E_{AS}$	$L=15\text{mH}, I_{AS}=2.5\text{A}$	52	mJ
Power Dissipation	$P_{tot}$	$T_C = 25^\circ\text{C}$	113	W
Operating and Storage Temperature	$T_J, T_{STG}$		-55 to 150	$^\circ\text{C}$
Max Lead Temperature for Soldering, 1/8" from Case for 5 Seconds	$T_L$		250	$^\circ\text{C}$

<sup>1</sup> Starting  $T_j = 25^\circ\text{C}$

**Electrical Characteristics** ( $T_J = +25^\circ\text{C}$  unless otherwise specified)

**Typical Performance - Static**

Parameter	Symbol	Test Conditions	Value			Units
			Min	Typ	Max	
Drain-Source Breakdown Voltage	$BV_{DS}$	$V_{GS}=0V, I_D=1mA$	650			V
Total Drain Leakage Current	$I_D$	$V_{DS} = 650V,$ $V_{GS} = 0V, T_J = 25^\circ\text{C}$		25	500	$\mu\text{A}$
		$V_{DS} = 650V,$ $V_{GS} = 0V, T_J = 150^\circ\text{C}$		65		
Total Gate Leakage Current	$I_G$	$V_{DS}=0V, T_J=25^\circ\text{C}$ $V_{GS}=-20V/+20V$		5	100	nA
Drain-Source On-Resistance	$R_{DS(on)}$	$V_{GS}=12V, I_F=25A,$ $T_J = 25^\circ\text{C}$		34	45	mΩ
		$V_{GS}=12V, I_F=25A,$ $T_J = 150^\circ\text{C}$		62	82	
Gate Threshold Voltage	$V_{G(th)}$	$V_{DS} = 5V, I_D = 10mA$	4.5	5	5.5	V
Gate Resistance	$R_G$	$V_{GS} = 0V, f = 1MHz$		1.1		Ω

**Typical Performance - Reverse Diode**

Parameter	Symbol	Test Conditions	Value			Units
			Min	Typ	Max	
Forward Voltage	$V_{FSD}$	$V_{GS} = 0V, I_F = 25A,$ $T_J = 25^\circ\text{C}$	-	1.55		V
		$I_F = 25A, T_J = 150^\circ\text{C}$	-	1.9		
Reverse Recovery Charge	$Q_{rr}$	$V_R=400V, I_F=25A,$ $di/dt = 1300A/us$		145		nC
Reverse Recovery Time	$t_{rr}$			55		ns

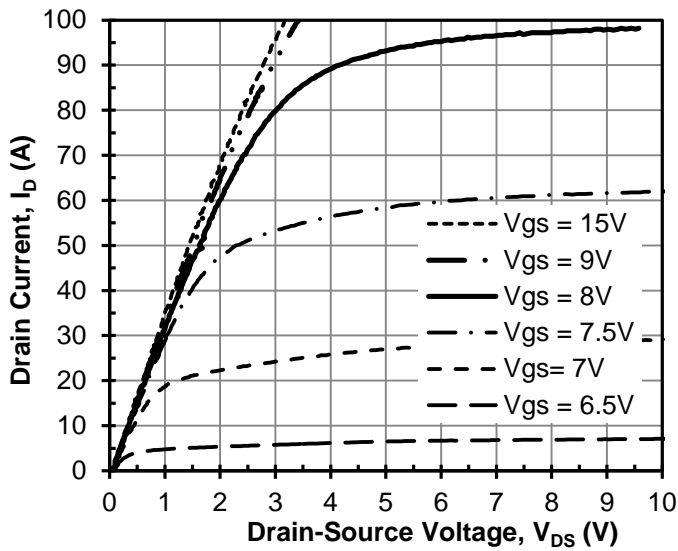
**Thermal characteristics**

Parameter	symbol	Test Conditions	Value			Units
			Min	Typ	Max	
Thermal Resistance, Junction-to-Case	$R_{\theta JC}$				1.1	$^\circ\text{C/W}$

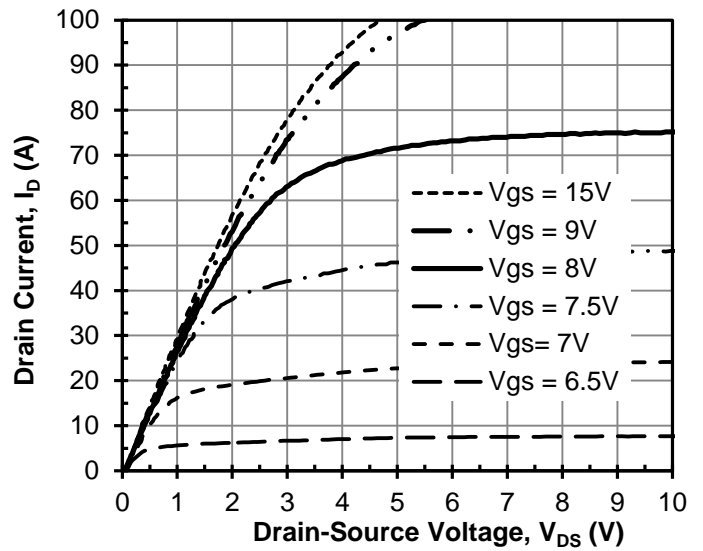
**Typical Performance - Dynamic**

Parameter	symbol	Test Conditions	Value			Units
			Min	Typ	Max	
Input Capacitance	$C_{iss}$	$V_{DS} = 400V,$ $V_{GS} = 0V,$ $f = 100kHz$		2107		pF
Output Capacitance	$C_{oss}$			80		
Reverse Transfer Capacitance	$C_{rss}$			5.7		
Effective Output Capacitance, Energy Related	$C_{oss(er)}$	$V_{DS} = 0V$ to 400V, $V_{GS} = 0V$		100		pF
Total Gate Charge	$Q_G$	$V_{DS}=400V, I_D = 25A,$ $V_{GS}=0V$ to 15V		58		nC
Gate-Drain Charge	$Q_{GD}$			15		
Gate-Source Charge	$Q_{GS}$			15		
Turn-on Delay Time	$t_{d(on)}$	$V_{DS}=400V, I_D=25A,$ Gate Driver =0V to +12V, Turn-on $R_{G,EXT} = 0\Omega,$ Turn-off $R_{G,EXT} = 20\Omega$ Inductive Load, $T_J = 25^\circ C$		29		ns
Rise Time	$t_r$			10		
Turn-off Delay Time	$t_{d(off)}$			70		
Fall Time	$t_f$			15		
Turn-on Energy	$E_{ON}$			196		
Turn-off Energy	$E_{OFF}$		101		$\mu J$	
Total Switching Energy	$E_{TOTAL}$		297			
Turn-on Delay Time	$t_{d(on)}$	$V_{DS}=400V, I_D=25A,$ Gate Driver =0V to +12V, Turn-on $R_{G,EXT} = 0\Omega,$ Turn-off $R_{G,EXT} = 20\Omega$ Inductive Load, $T_J = 150^\circ C$		31		ns
Rise Time	$t_r$			14		
Turn-off Delay Time	$t_{d(off)}$			78		
Fall Time	$t_f$			17		
Turn-on Energy	$E_{ON}$			215		$\mu J$
Turn-off Energy	$E_{OFF}$			124		
Total Switching Energy	$E_{TOTAL}$			339		

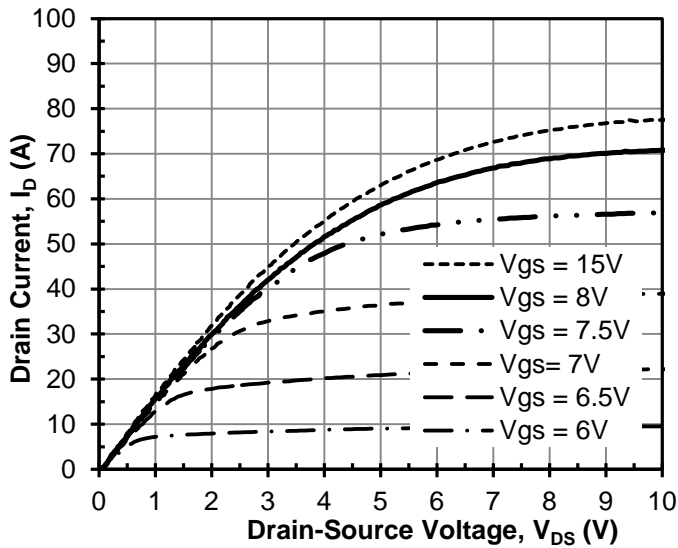
**Typical Performance Diagrams**



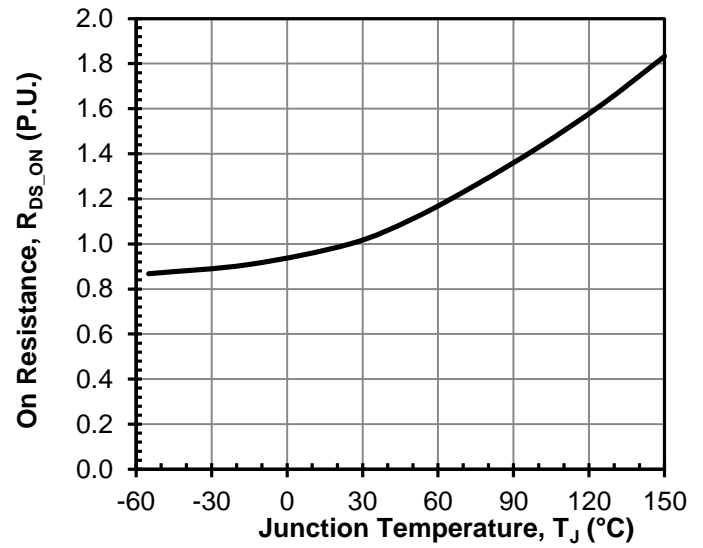
**Figure 1 Typical output characteristics at  $T_j = -55^\circ\text{C}$ ,  $t_p < 250\mu\text{s}$**



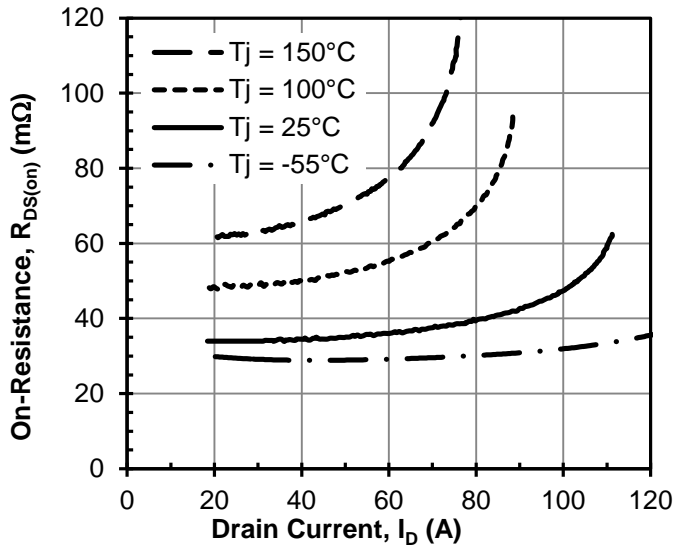
**Figure 2 Typical output characteristics at  $T_j = 25^\circ\text{C}$ ,  $t_p < 250\mu\text{s}$**



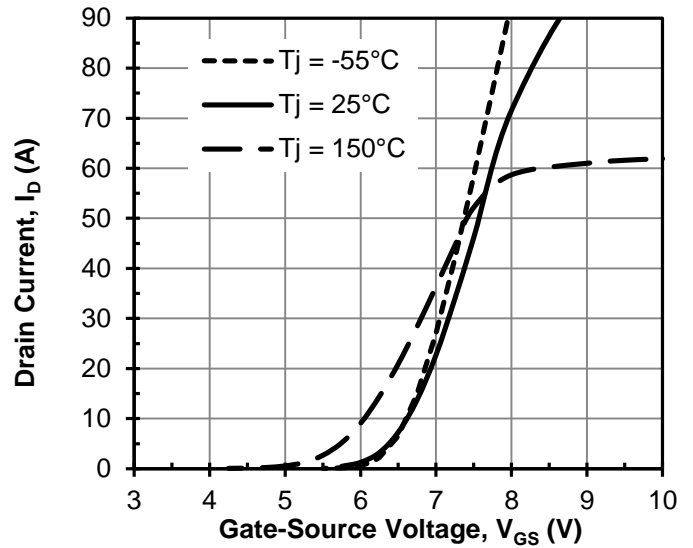
**Figure 3 Typical output characteristics at  $T_j = 150^\circ\text{C}$ ,  $t_p < 250\mu\text{s}$**



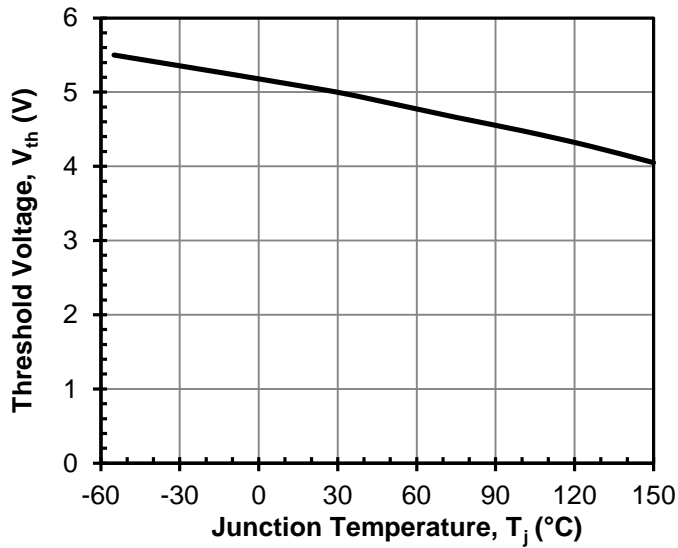
**Figure 4 Normalized on-resistance vs. temperature at  $V_{GS} = 12\text{V}$  and  $I_D = 25\text{A}$**



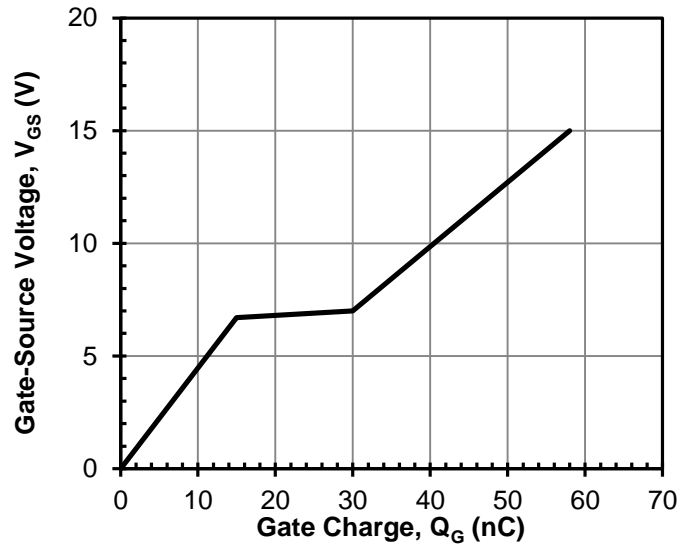
**Figure 5 Typical drain-source on-resistance at  $V_{GS} = 12V$**



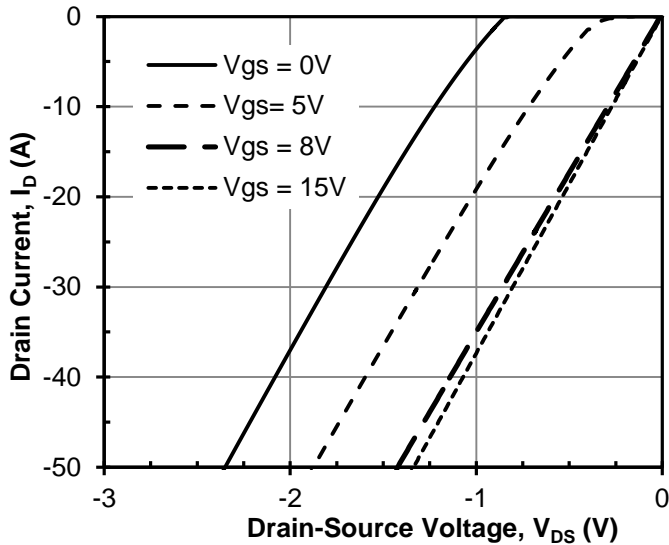
**Figure 6 Typical transfer characteristics at  $V_{DS} = 5V$**



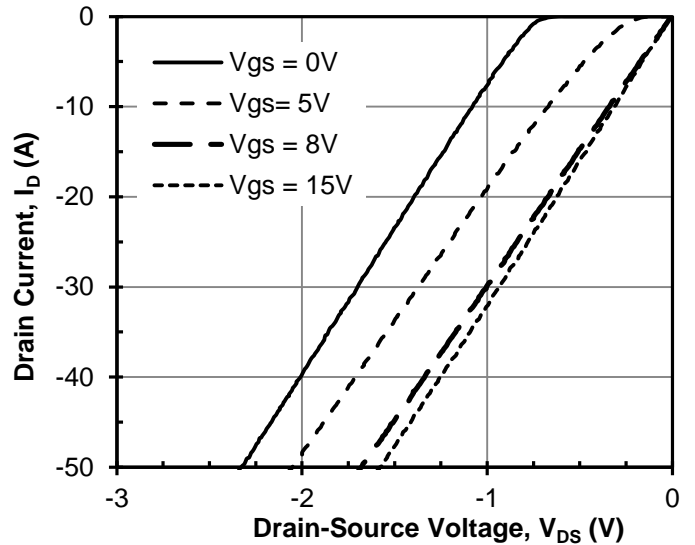
**Figure 7 Threshold voltage vs.  $T_j$  at  $V_{DS} = 5V$  and  $I_D = 10mA$**



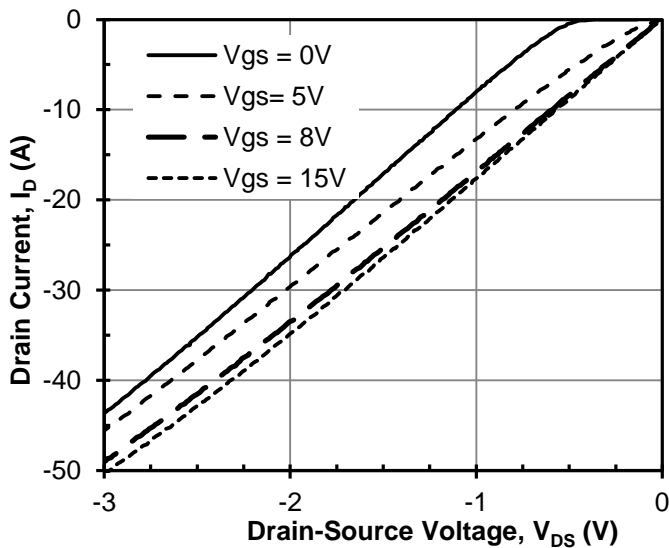
**Figure 8 Typical gate charge at  $V_{DS} = 400V$  and  $I_D = 25A$**



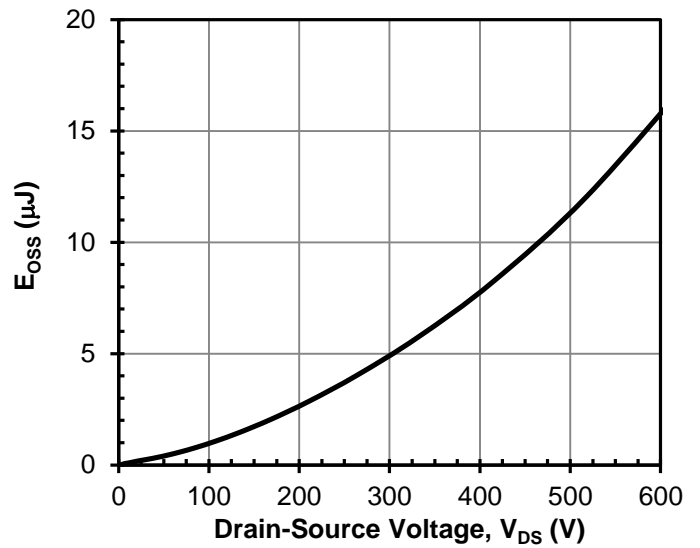
**Figure 9 3rd quadrant characteristics at  $T_J = -55^\circ\text{C}$**



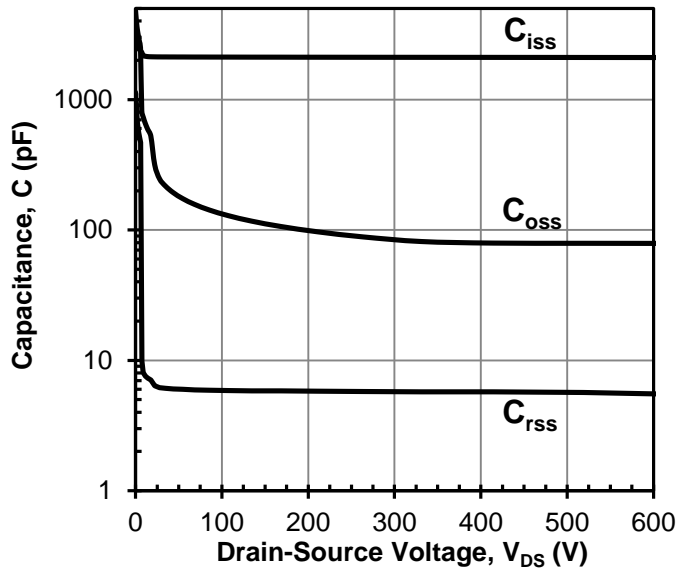
**Figure 10 3rd quadrant characteristics at  $T_J = 25^\circ\text{C}$**



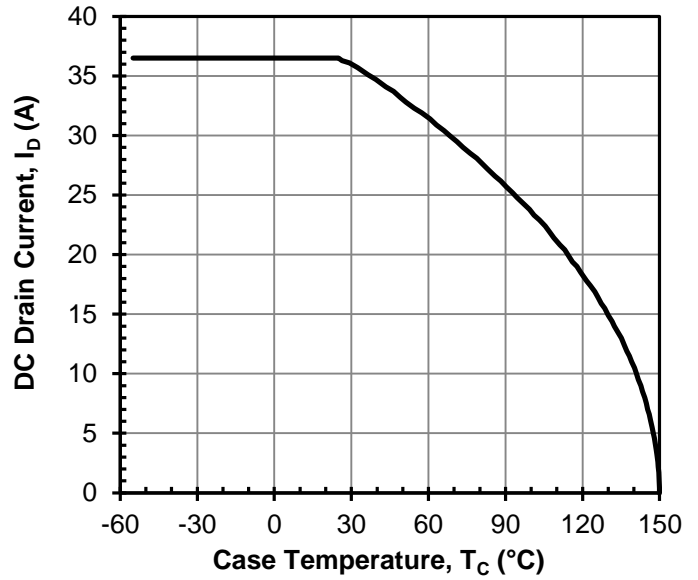
**Figure 11 3rd quadrant characteristics at  $T_J = 150^\circ\text{C}$**



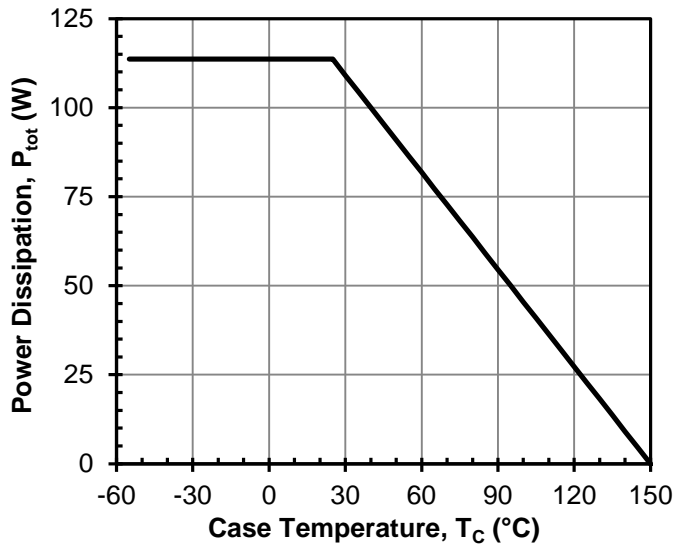
**Figure 12 Typical stored energy in  $C_{OSS}$  at  $V_{GS} = 0V$**



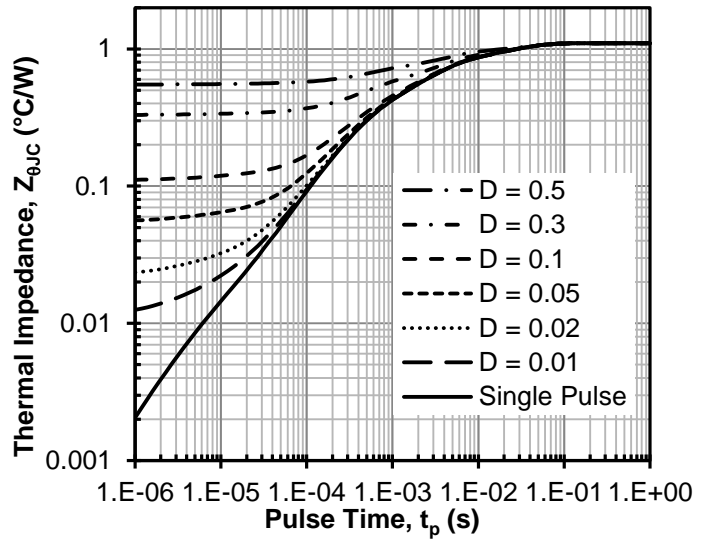
**Figure 13 Typical capacitances at 100kHz and  $V_{GS} = 0V$**



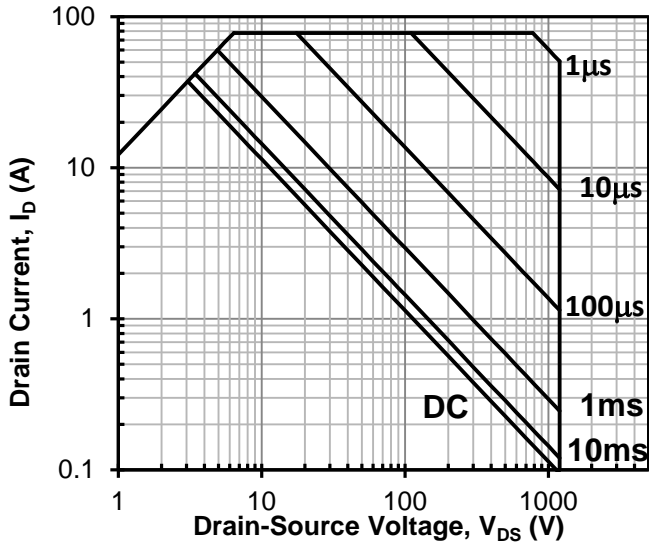
**Figure 14 DC drain current derating**



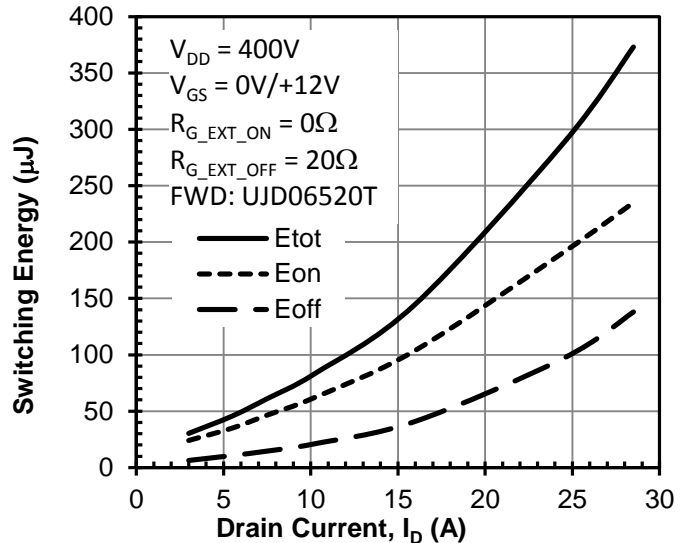
**Figure 15 Total power Dissipation**



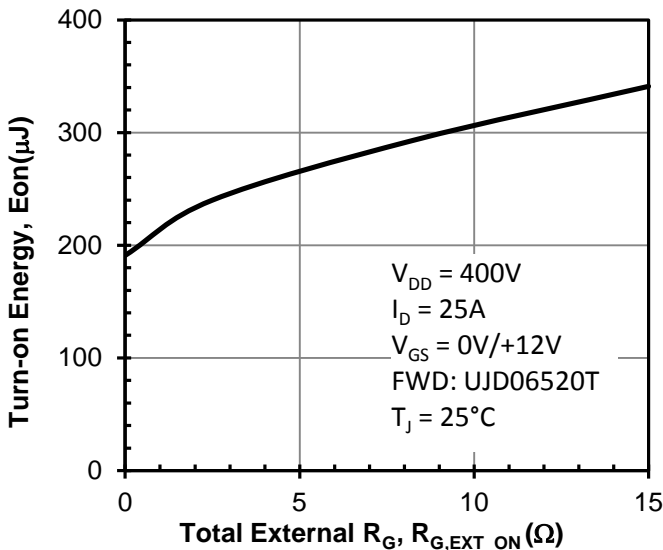
**Figure 16 Maximum transient thermal impedance**



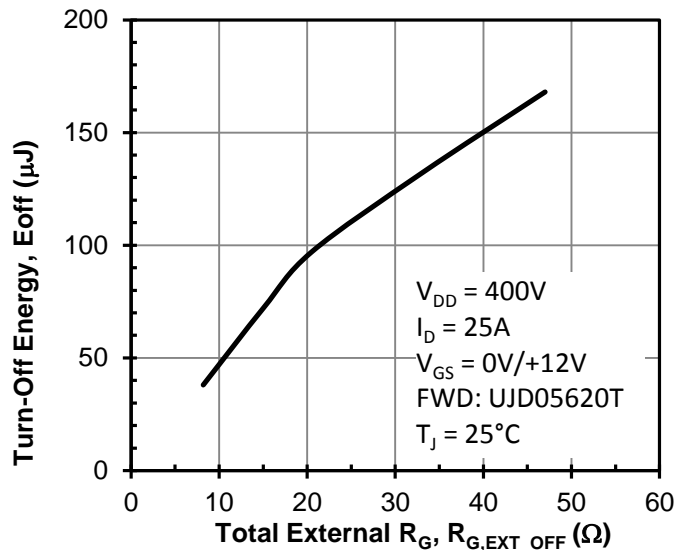
**Figure 17 Safe operation area**  
 $T_c = 25^\circ\text{C}$ ,  $D = 0$ , Parameter  $t_p$



**Figure 18 Clamped inductive switching energy vs. drain current at  $T_J = 25^\circ\text{C}$**

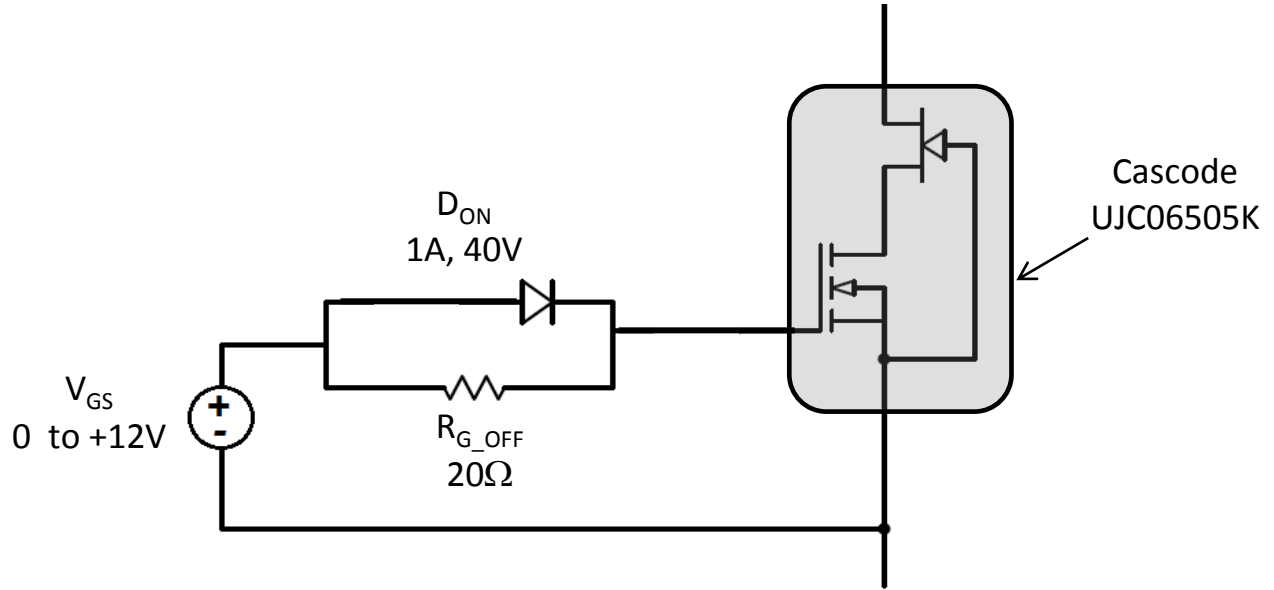


**Figure 19 Clamped inductive switching turn-on energy vs.  $R_{G\_EXT\_ON}$**



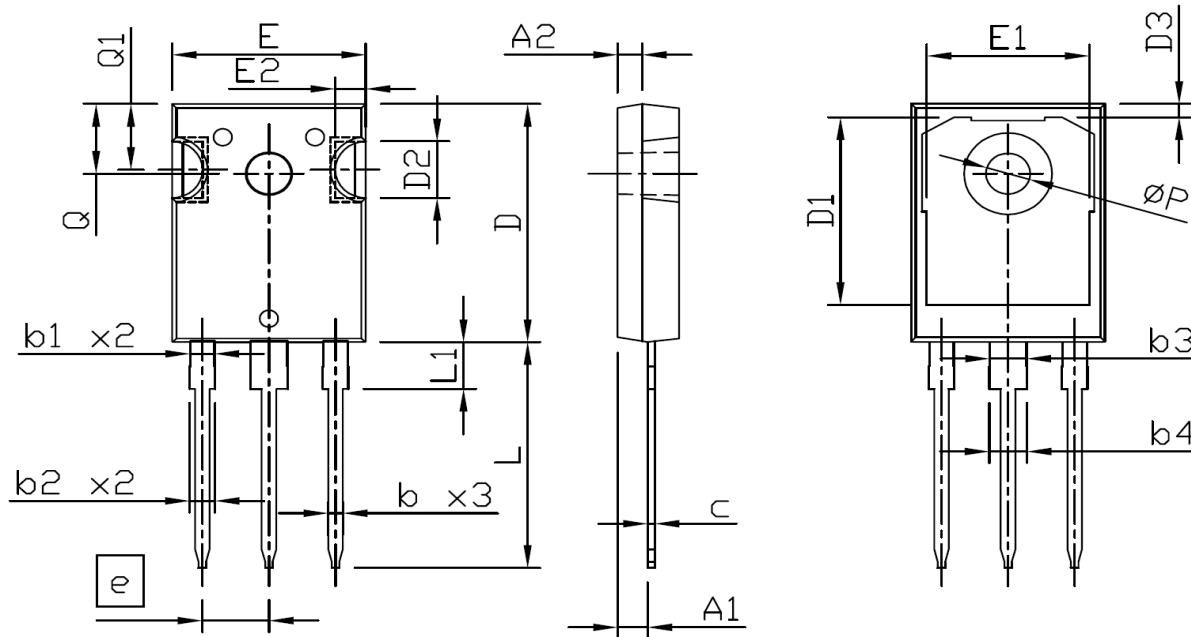
**Figure 20 Clamped inductive switching turn-off energy vs.  $R_{G\_EXT\_OFF}$**



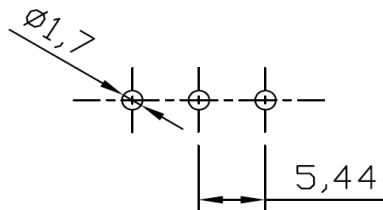


**Figure 21 Recommended gate drive**

**Mechanical Characteristics**



RECOMMENDED LAND PATTERN



UNIT: mm

SYMBOLS	DIMENSIONS IN MILLIMETERS			DIMENSIONS IN INCHES		
	MIN	NOM	MAX	MIN	NOM	MAX
A	4,90	5,00	5,10	0,193	0,197	0,201
A1	2,31	2,42	2,52	0,091	0,095	0,099
A2	1,90	2,00	2,10	0,075	0,079	0,083
b	1,16	1,22	1,27	0,046	0,048	0,050
b1	1,96	2,02	2,07	0,078	0,080	0,081
b2	2,00	2,10	2,20	0,079	0,083	0,087
b3	2,96	3,02	3,07	0,117	0,119	0,121
b4	3,00	3,10	3,20	0,118	0,122	0,126
c	0,59	0,62	0,66	0,023	0,024	0,026
D	20,90	21,00	21,10	0,823	0,827	0,831
D1	16,25	16,55	16,85	0,640	0,652	0,663
D2	5,00 TYP			0,197 TYP		
D3	1,05	1,20	1,35	0,041	0,047	0,053
e	5,44 BSC			0,214 BSC		
E	15,70	15,80	15,90	0,618	0,622	0,626
E1	13,06	13,26	13,50	0,514	0,522	0,530
E2	2,50 TYP			0,098 TYP		
L	19,72	19,92	20,12	0,776	0,784	0,792
L1	---	---	4,30	---	---	0,169
Q	6,15 BSC			0,242 BSC		
Q1	5,60	5,80	6,00	0,220	0,228	0,236
ØP	3,55	3,60	3,70	0,140	0,142	0,146

**Disclaimer**

United Silicon Carbide, Inc. reserves the right to change or modify any of the products and their inherent physical and technical specifications without prior notice. United Silicon Carbide, Inc. assumes no responsibility or liability for any errors or inaccuracies within.

Information on all products and contained herein is intended for description only. No license, express or implied, to any intellectual property rights is granted within this document.

United Silicon Carbide, Inc. assumes no liability whatsoever relating to the choice, selection or use of the United Silicon Carbide, Inc. products and services described herein.