

DATASHEET

UF3C120150B7S

1200V-150mΩ SiC Cascode

Rev. A, January 2021

Description

This SiC FET device is based on a unique ‘cascode’ circuit configuration, in which a normally-on SiC JFET is co-packaged with a Si MOSFET to produce a normally-off SiC FET device. The device’s standard gate-drive characteristics allows for a true “drop-in replacement” to Si IGBTs, Si FETs, SiC MOSFETs or Si superjunction devices. Available in the D²PAK-7L package, this device exhibits ultra-low gate charge and exceptional reverse recovery characteristics, making it ideal for switching inductive loads, and any application requiring standard gate drive.

Features

- ◆ On-resistance $R_{DS(on)}$: 150mΩ (typ)
- ◆ Operating temperature: 175°C (max)
- ◆ Excellent reverse recovery: Q_{rr} = 67nC
- ◆ Low body diode V_{FSD} : 1.46V
- ◆ Low gate charge: Q_G = 25.7nC
- ◆ Threshold voltage $V_{G(th)}$: 4.4V (typ) allowing 0 to 15V drive
- ◆ Package creepage and clearance distance > 6.1mm
- ◆ Kelvin source pin for optimized switching performance
- ◆ ESD protected, HBM class 2

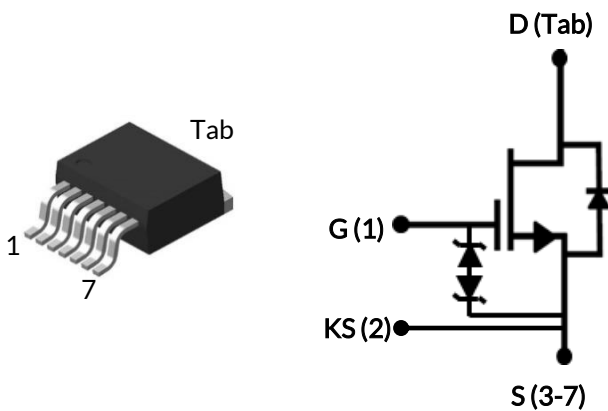

| Part Number | Package | Marking |
|---------------|-----------------------|---------------|
| UF3C120150B7S | D ² PAK-7L | UF3C120150B7S |

Typical applications

- Any controlled environment such as
- ◆ Telecom and Server Power
 - ◆ Industrial power supplies
 - ◆ Power factor correction modules
 - ◆ Motor drives
 - ◆ Induction heating



Maximum Ratings

| Parameter | Symbol | Test Conditions | Value | Units |
|---|----------------|-----------------------------------|------------|------------------|
| Drain-source voltage | V_{DS} | | 1200 | V |
| Gate-source voltage | V_{GS} | DC | -25 to +25 | V |
| Continuous drain current ¹ | I_D | $T_C = 25^\circ\text{C}$ | 17 | A |
| | | $T_C = 100^\circ\text{C}$ | 12.5 | A |
| Pulsed drain current ² | I_{DM} | $T_C = 25^\circ\text{C}$ | 38 | A |
| Single pulsed avalanche energy ³ | E_{AS} | $L=15\text{mH}, I_{AS}=2\text{A}$ | 30 | mJ |
| Power dissipation | P_{tot} | $T_C = 25^\circ\text{C}$ | 136 | W |
| Maximum junction temperature | $T_{J,max}$ | | 175 | $^\circ\text{C}$ |
| Operating and storage temperature | T_J, T_{STG} | | -55 to 175 | $^\circ\text{C}$ |
| Reflow soldering temperature | T_{solder} | reflow MSL 3 | 260 | $^\circ\text{C}$ |

1. Limited by $T_{J,max}$

2. Pulse width t_p limited by $T_{J,max}$

3. Starting $T_J = 25^\circ\text{C}$

Thermal Characteristics

| Parameter | Symbol | Test Conditions | Value | | | Units |
|--------------------------------------|-----------------|-----------------|-------|------|-----|---------------------------|
| | | | Min | Typ | Max | |
| Thermal resistance, junction-to-case | $R_{\theta JC}$ | | | 0.85 | 1.1 | $^\circ\text{C}/\text{W}$ |

Electrical Characteristics ($T_J = +25^\circ\text{C}$ unless otherwise specified)

Typical Performance - Static

| Parameter | Symbol | Test Conditions | Value | | | Units |
|--------------------------------|--------------|---|-------|-----|----------|---------------|
| | | | Min | Typ | Max | |
| Drain-source breakdown voltage | BV_{DS} | $V_{GS}=0V, I_D=1mA$ | 1200 | | | V |
| Total drain leakage current | I_{DSS} | $V_{DS}=1200V, V_{GS}=0V, T_J=25^\circ\text{C}$ | | 2 | 50 | μA |
| | | $V_{DS}=1200V, V_{GS}=0V, T_J=175^\circ\text{C}$ | | 17 | | |
| Total gate leakage current | I_{GSS} | $V_{DS}=0V, T_J=25^\circ\text{C}, V_{GS}=-20V / +20V$ | | 4 | ± 20 | μA |
| Drain-source on-resistance | $R_{DS(on)}$ | $V_{GS}=12V, I_D=5A, T_J=25^\circ\text{C}$ | | 150 | 180 | m Ω |
| | | $V_{GS}=12V, I_D=5A, T_J=125^\circ\text{C}$ | | 250 | | |
| | | $V_{GS}=12V, I_D=5A, T_J=175^\circ\text{C}$ | | 330 | | |
| Gate threshold voltage | $V_{G(th)}$ | $V_{DS}=5V, I_D=10mA$ | 3.5 | 4.4 | 5.5 | V |
| Gate resistance | R_G | f=1MHz, open drain | | 4.6 | | Ω |

Typical Performance - Reverse Diode

| Parameter | Symbol | Test Conditions | Value | | | Units |
|---|---------------|---|-------|------|-----|-------|
| | | | Min | Typ | Max | |
| Diode continuous forward current ¹ | I_S | $T_C=25^\circ\text{C}$ | | | 17 | A |
| Diode pulse current ² | $I_{S,pulse}$ | $T_C=25^\circ\text{C}$ | | | 38 | A |
| Forward voltage | V_{FSD} | $V_{GS}=0V, I_F=5A, T_J=25^\circ\text{C}$ | | 1.46 | 2 | V |
| | | $V_{GS}=0V, I_F=5A, T_J=175^\circ\text{C}$ | | 2 | | |
| Reverse recovery charge | Q_{rr} | $V_R=800V, I_F=13A, V_{GS}=-5V, R_{G,EXT}=22\Omega, di/dt=1700A/\mu\text{s}, T_J=25^\circ\text{C}$ | | 67 | | nC |
| Reverse recovery time | t_{rr} | $T_J=25^\circ\text{C}$ | | 24 | | ns |
| Reverse recovery charge | Q_{rr} | $V_R=800V, I_F=13A, V_{GS}=-5V, R_{G,EXT}=22\Omega, di/dt=1700A/\mu\text{s}, T_J=150^\circ\text{C}$ | | 64 | | nC |
| Reverse recovery time | t_{rr} | $T_J=150^\circ\text{C}$ | | 24 | | ns |

Typical Performance - Dynamic

| Parameter | Symbol | Test Conditions | Value | | | Units |
|--|---------------|--|-------|------|-----|---------|
| | | | Min | Typ | Max | |
| Input capacitance | C_{iss} | $V_{DS}=100V, V_{GS}=0V$ $f=100kHz$ | | 738 | | pF |
| Output capacitance | C_{oss} | | | 58 | | |
| Reverse transfer capacitance | C_{rss} | | | 1.8 | | |
| Effective output capacitance, energy related | $C_{oss(er)}$ | $V_{DS}=0V$ to 800V, $V_{GS}=0V$ | | 34 | | pF |
| Effective output capacitance, time related | $C_{oss(tr)}$ | $V_{DS}=0V$ to 800V, $V_{GS}=0V$ | | 68 | | pF |
| C_{oss} stored energy | E_{oss} | $V_{DS}=800V, V_{GS}=0V$ | | 10.8 | | μJ |
| Total gate charge | Q_G | $V_{DS}=800V, I_D=13A,$ $V_{GS} = -5V$ to 12V | | 25.7 | | nC |
| Gate-drain charge | Q_{GD} | | | 6 | | |
| Gate-source charge | Q_{GS} | | | 10 | | |
| Turn-on delay time | $t_{d(on)}$ | $V_{DS}=800V, I_D=13A,$ Gate Driver = -5V to +12V, Turn-on $R_{G,EXT}=8.5\Omega,$ Turn-off $R_{G,EXT}=20\Omega$ Inductive Load, | | 32 | | ns |
| Rise time | t_r | | | 6 | | |
| Turn-off delay time | $t_{d(off)}$ | | | 32 | | |
| Fall time | t_f | | | 8 | | |
| Turn-on energy | E_{ON} | FWD: same device with $V_{GS}=-5V, R_G=20\Omega,$ $T_J=25^\circ C$ | | 208 | | μJ |
| Turn-off energy | E_{OFF} | | | 28 | | |
| Total switching energy | E_{TOTAL} | | | 236 | | |
| Turn-on delay time | $t_{d(on)}$ | $V_{DS}=800V, I_D=13A,$ Gate Driver = -5V to +12V, Turn-on $R_{G,EXT}=8.5\Omega,$ Turn-off $R_{G,EXT}=20\Omega$ Inductive Load, | | 32 | | ns |
| Rise time | t_r | | | 5 | | |
| Turn-off delay time | $t_{d(off)}$ | | | 32 | | |
| Fall time | t_f | | | 7 | | |
| Turn-on energy | E_{ON} | FWD: same device with $V_{GS}=-5V, R_G=20\Omega,$ $T_J=150^\circ C$ | | 201 | | μJ |
| Turn-off energy | E_{OFF} | | | 23 | | |
| Total switching energy | E_{TOTAL} | | | 224 | | |

Typical Performance Diagrams

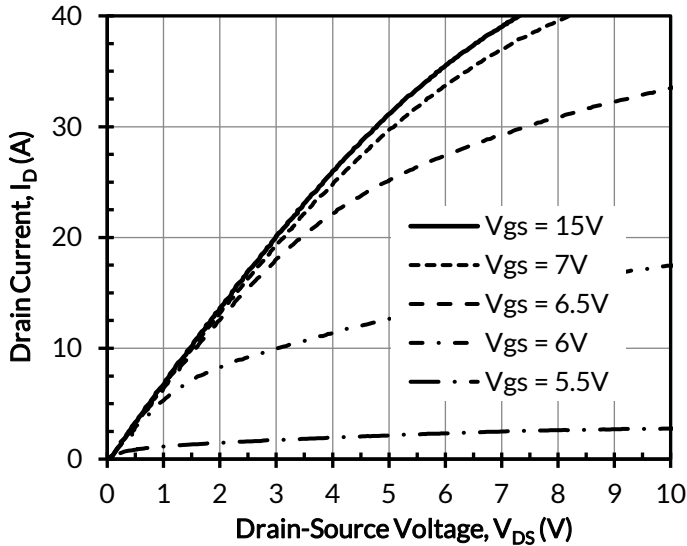

Figure 1. Typical output characteristics at $T_J = -55^\circ\text{C}$, $t_p < 250\mu\text{s}$

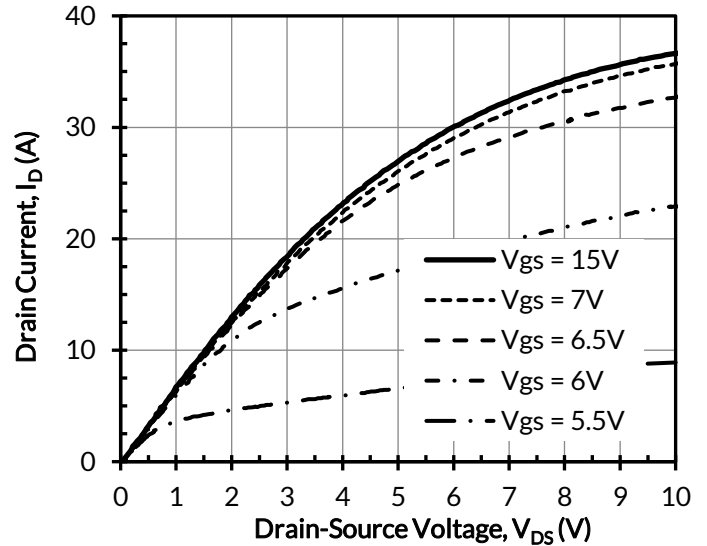

Figure 2. Typical output characteristics at $T_J = 25^\circ\text{C}$, $t_p < 250\mu\text{s}$

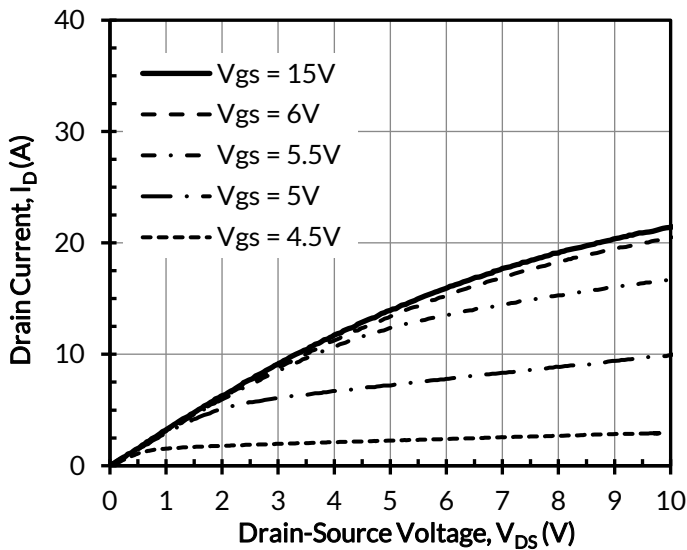

Figure 3. Typical output characteristics at $T_J = 175^\circ\text{C}$, $t_p < 250\mu\text{s}$

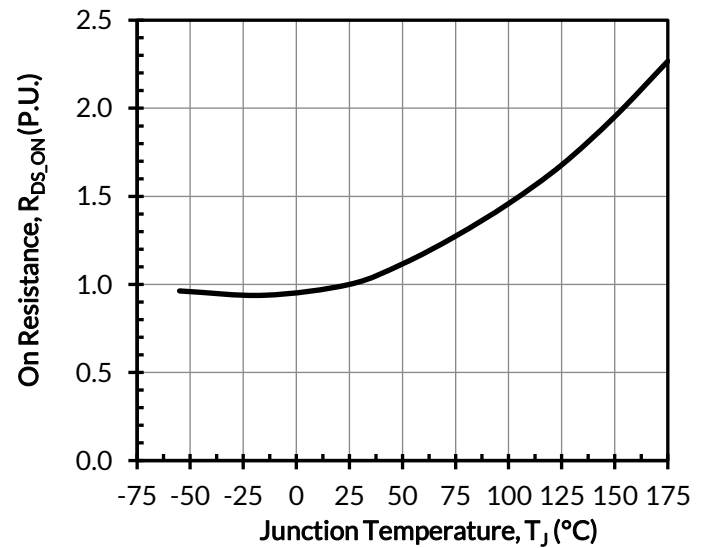

Figure 4. Normalized on-resistance vs. temperature at $V_{GS} = 12\text{V}$ and $I_D = 5\text{A}$

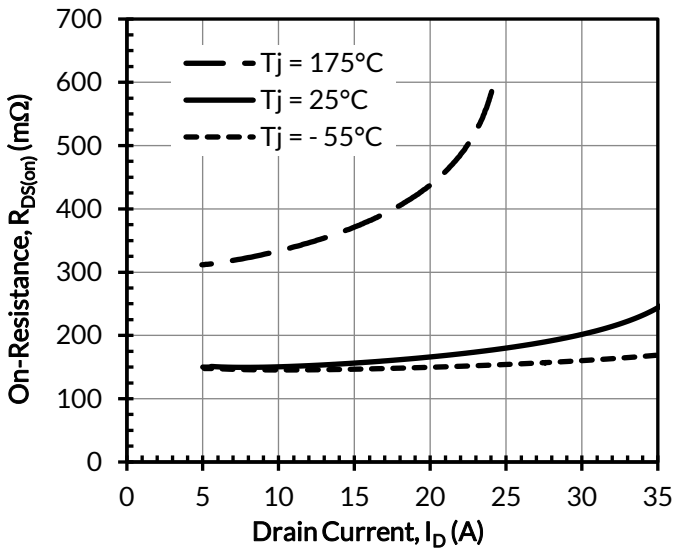

Figure 5. Typical drain-source on-resistances at $V_{GS} = 12\text{V}$

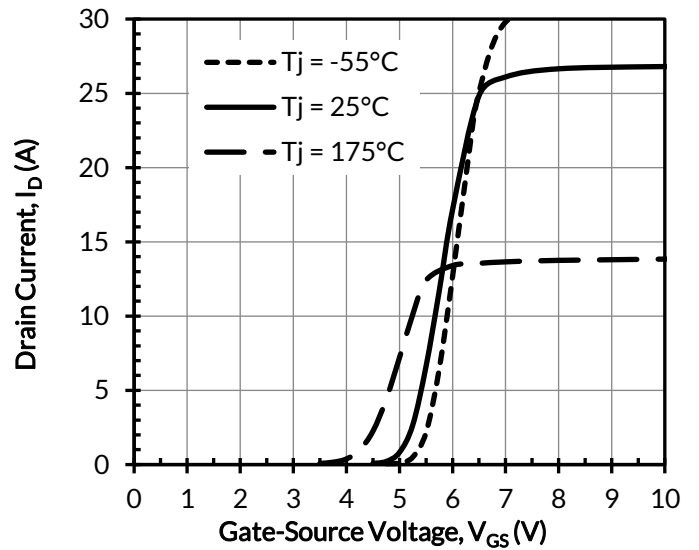

Figure 6. Typical transfer characteristics at $V_{DS} = 5\text{V}$

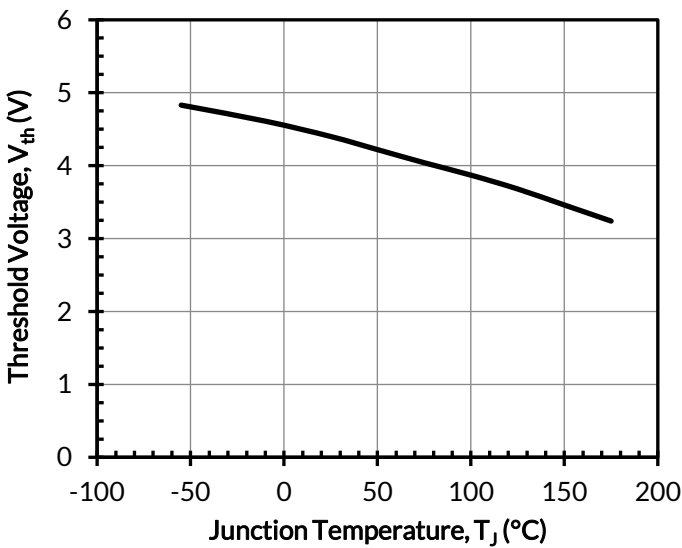

Figure 7. Threshold voltage vs. junction temperature at $V_{DS} = 5\text{V}$ and $I_D = 10\text{mA}$

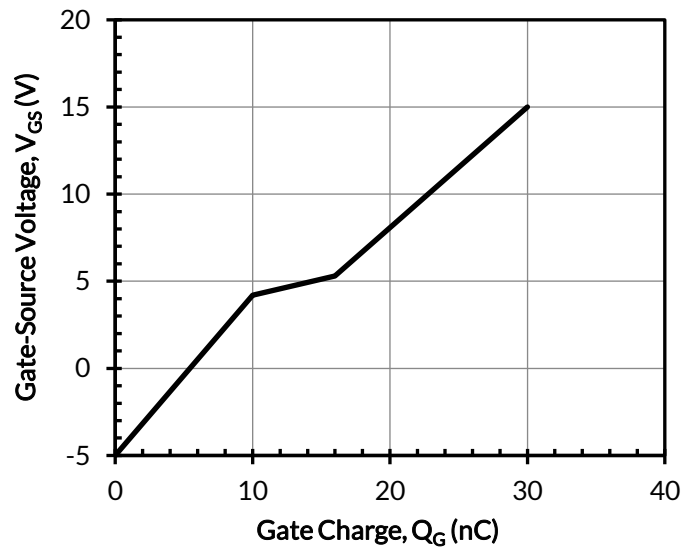

Figure 8. Typical gate charge at $V_{DS} = 800\text{V}$ and $I_D = 13\text{A}$

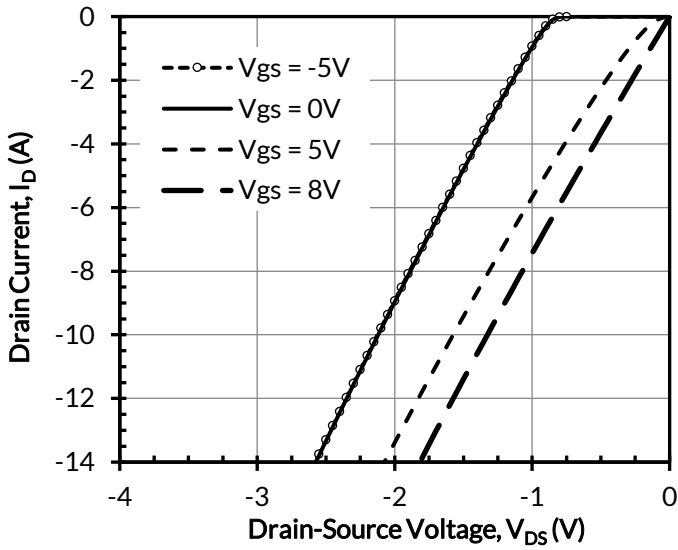

Figure 9. 3rd quadrant characteristics at $T_j = -55^\circ\text{C}$

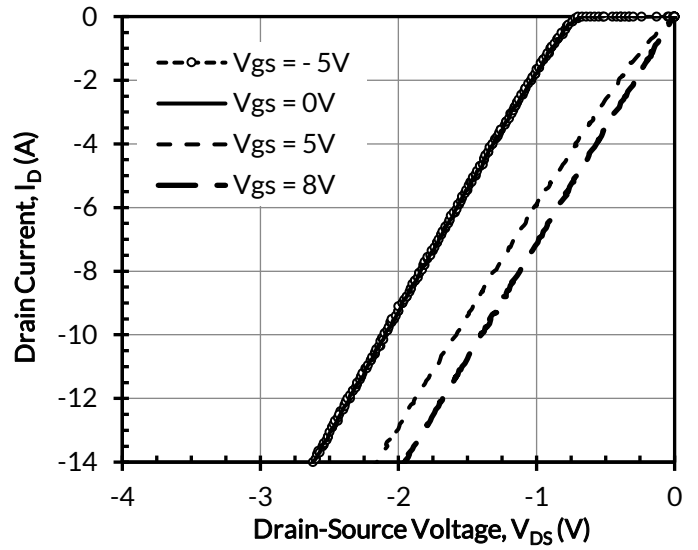

Figure 10. 3rd quadrant characteristics at $T_j = 25^\circ\text{C}$

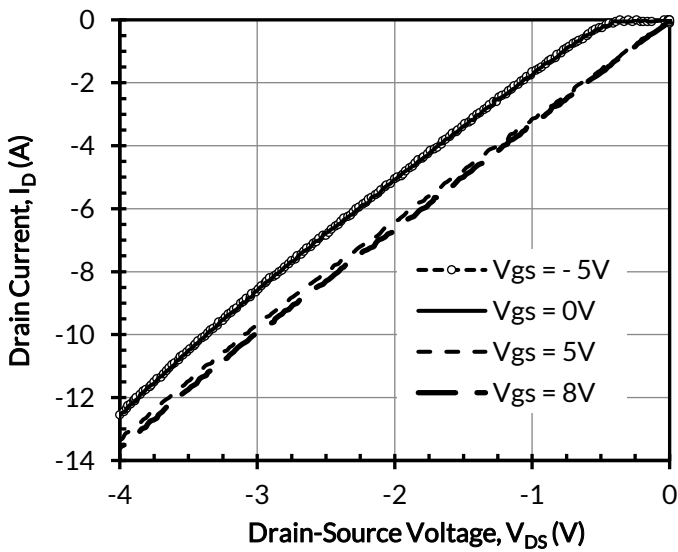

Figure 11. 3rd quadrant characteristics at $T_j = 175^\circ\text{C}$

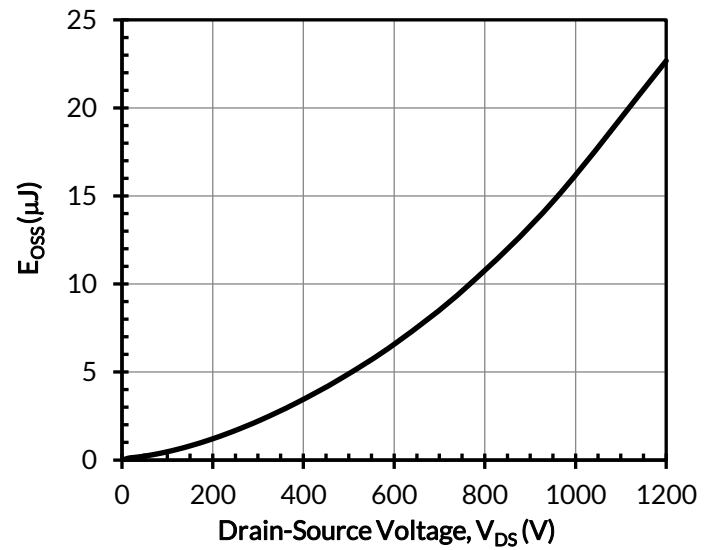

Figure 12. Typical stored energy in C_{OSS} at $V_{GS} = 0\text{V}$

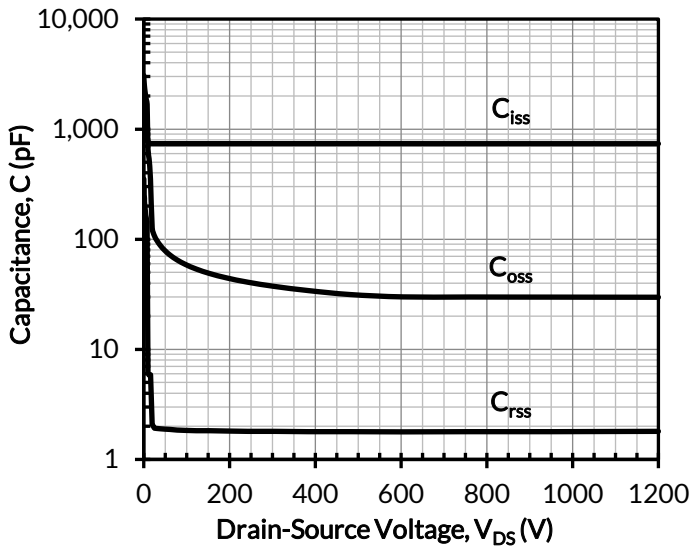

Figure 13. Typical capacitances at $f = 100\text{kHz}$ and $V_{GS} = 0\text{V}$

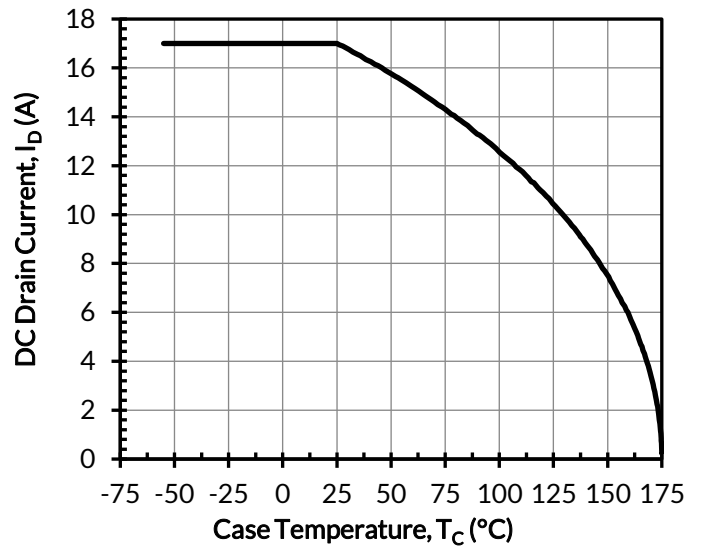

Figure 14. DC drain current derating

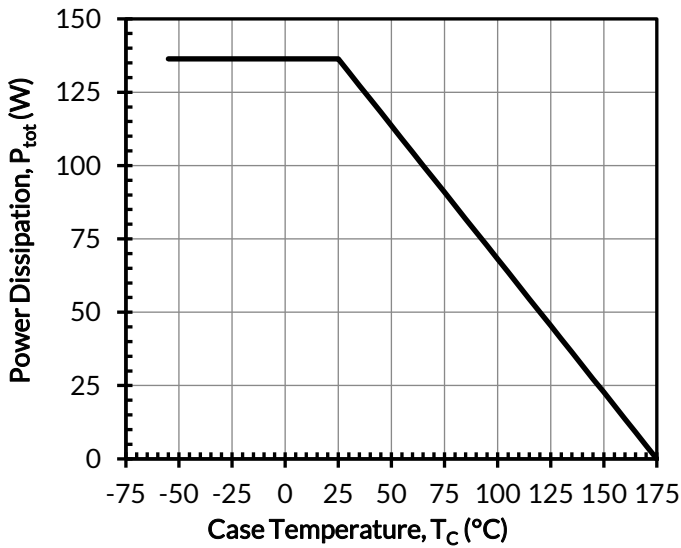

Figure 15. Total power dissipation

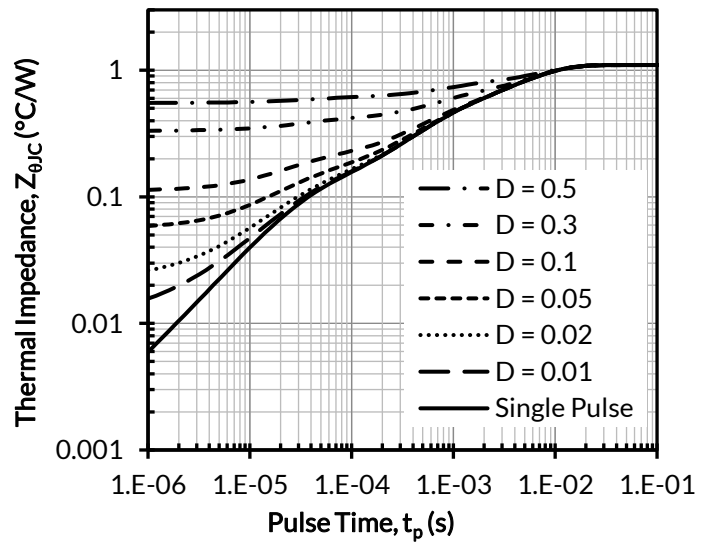

Figure 16. Maximum transient thermal impedance

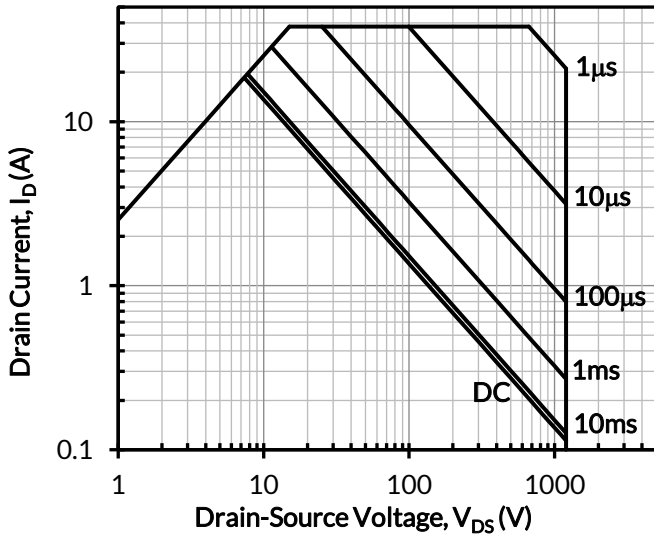

Figure 17. Safe operation area at $T_C = 25^\circ\text{C}$, $D = 0$, Parameter t_p

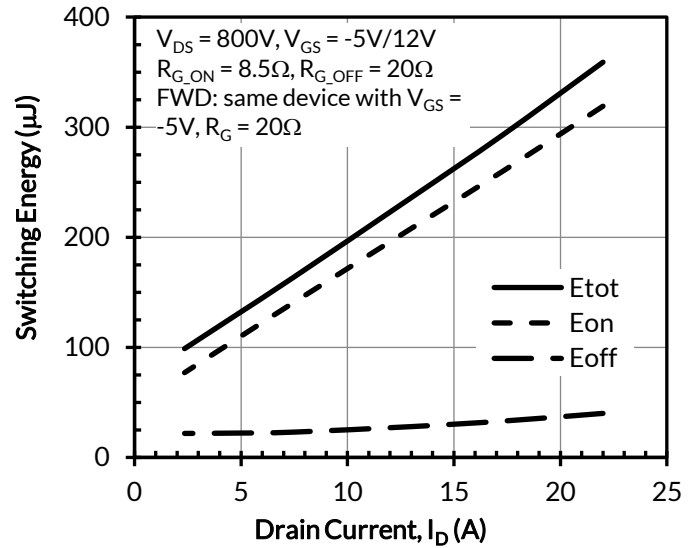

Figure 18. Clamped inductive switching energy vs. drain current at $T_J = 25^\circ\text{C}$

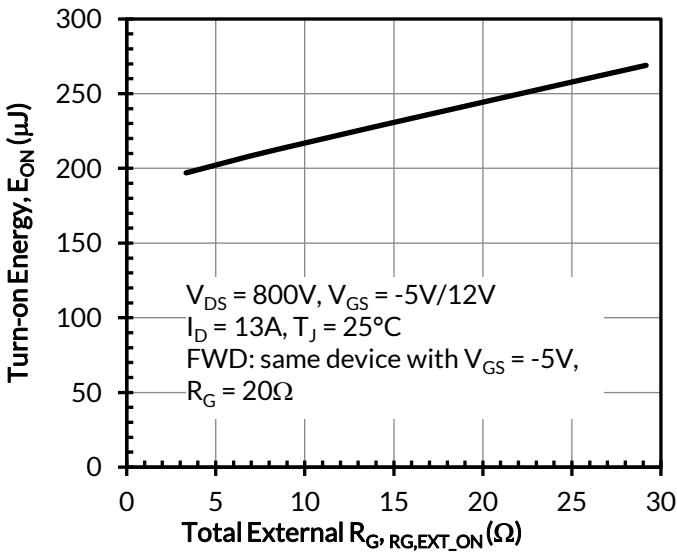

Figure 19. Clamped inductive switching turn-on energy vs. R_{G,EXT_ON}

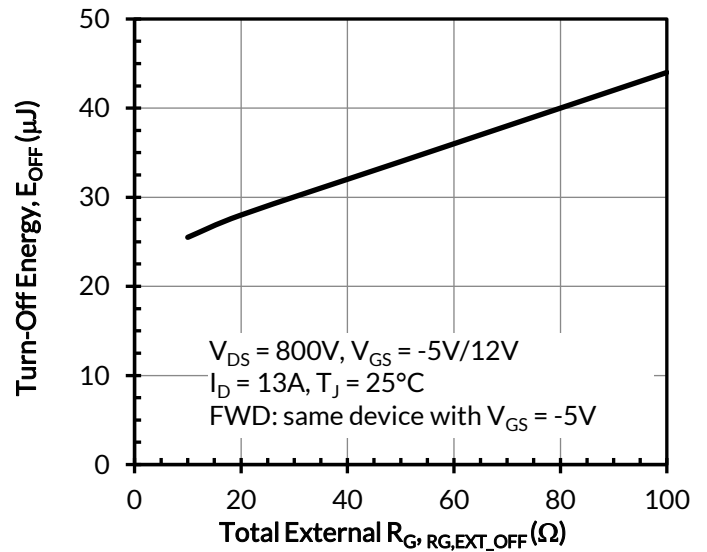

Figure 20. Clamped inductive switching turn-off energy vs. R_{G,EXT_OFF}

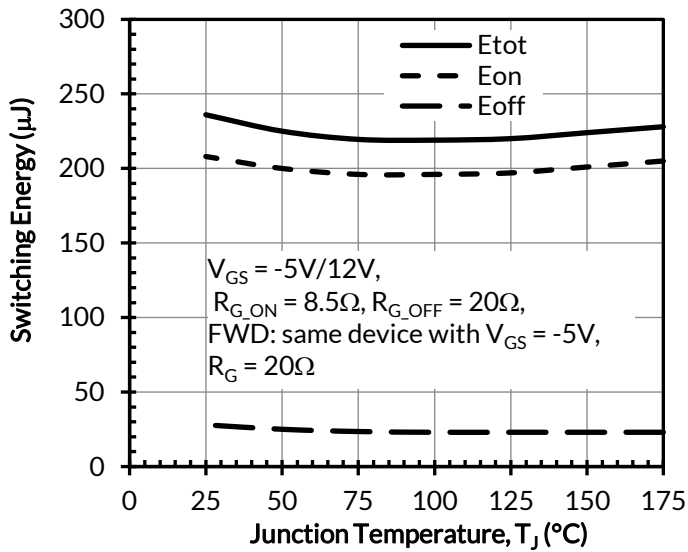

Figure 21. Clamped inductive switching energy vs. junction temperature at $V_{DS} = 800V$ and $I_D = 13A$

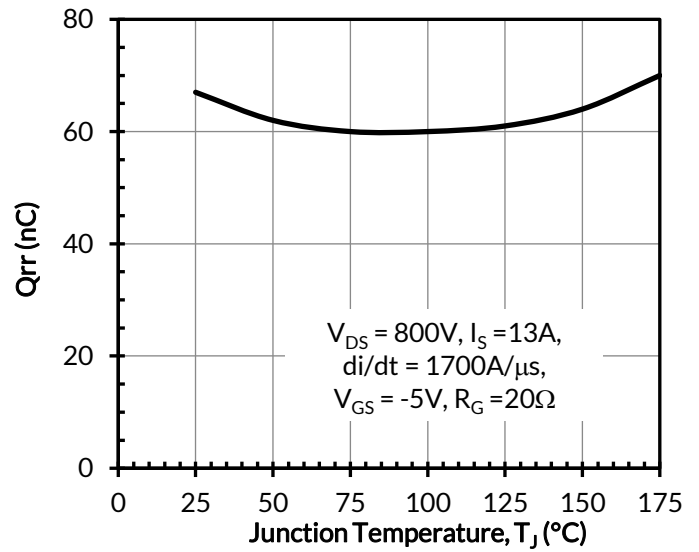

Figure 22. Reverse recovery charge Q_{rr} vs. junction temperature

Applications Information

SiC FETs are enhancement-mode power switches formed by a high-voltage SiC depletion-mode JFET and a low-voltage silicon MOSFET connected in series. The silicon MOSFET serves as the control unit while the SiC JFET provides high voltage blocking in the off state. This combination of devices in a single package provides compatibility with standard gate drivers and offers superior performance in terms of low on-resistance ($R_{DS(on)}$), output capacitance (C_{oss}), gate charge (Q_G), and reverse recovery charge (Q_{rr}) leading to low conduction and switching losses. The SiC FETs also provide excellent reverse conduction capability eliminating the need for an external anti-parallel diode.

Like other high performance power switches, proper PCB layout design to minimize circuit parasitics is strongly recommended due to the high dv/dt and di/dt rates. An external gate resistor is recommended when the FET is working in the diode mode in order to achieve the optimum reverse recovery performance. For more information on SiC FET operation, see www.unitedsic.com.

Disclaimer

UnitedSiC reserves the right to change or modify any of the products and their inherent physical and technical specifications without prior notice. UnitedSiC assumes no responsibility or liability for any errors or inaccuracies within.

Information on all products and contained herein is intended for description only. No license, express or implied, to any intellectual property rights is granted within this document.

UnitedSiC assumes no liability whatsoever relating to the choice, selection or use of the UnitedSiC products and services described herein.