

## Description

United Silicon Carbide's cascode products co-package its high-performance G3 SiC JFETs with a cascode optimized MOSFET to produce the only standard gate drive SiC device in the market today. This series exhibits ultra-low gate charge, but also the best reverse recovery characteristics of any device of similar ratings. These devices are excellent for switching inductive loads, and any application requiring standard gate drive.

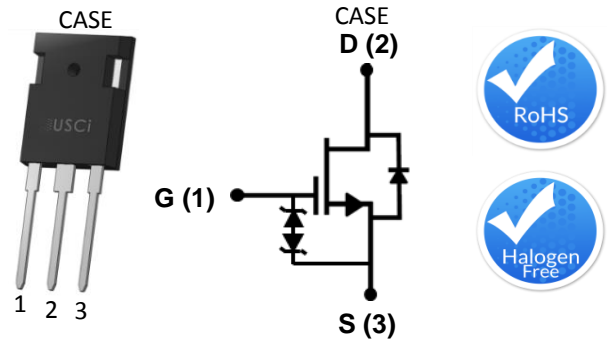

Part Number	Package	Marking
UJ3C065030K3S	TO-247-3L	UJ3C065030K3S

## Features

- ◆ Typical on-resistance  $R_{DS(on),typ}$  of 27mΩ
- ◆ Maximum operating temperature of 175°C
- ◆ Excellent reverse recovery
- ◆ Low gate charge
- ◆ Low intrinsic capacitance
- ◆ ESD protected, HBM class 2

## Typical Applications

- ◆ EV charging
- ◆ PV inverters
- ◆ Switch mode power supplies
- ◆ Power factor correction modules
- ◆ Motor drives
- ◆ Induction heating

## Maximum Ratings

Parameter	Symbol	Test Conditions	Value	Units
Drain-source voltage	$V_{DS}$		650	V
Gate-source voltage	$V_{GS}$	DC	-25 to +25	V
Continuous drain current <sup>1</sup>	$I_D$	$T_C=25^\circ\text{C}$	85	A
		$T_C=100^\circ\text{C}$	62	A
Pulsed drain current <sup>2</sup>	$I_{DM}$	$T_C=25^\circ\text{C}$	230	A
Single pulsed avalanche energy <sup>3</sup>	$E_{AS}$	$L=15\text{mH}$ , $I_{AS}=4\text{A}$	120	mJ
Power dissipation	$P_{tot}$	$T_C=25^\circ\text{C}$	441	W
Maximum junction temperature	$T_{J,max}$		175	°C
Operating and storage temperature	$T_J$ , $T_{STG}$		-55 to 175	°C
Max. lead temperature for soldering, 1/8" from case for 5 seconds	$T_L$		250	°C

1 Limited by  $T_{J,max}$

2 Pulse width  $t_p$  limited by  $T_{J,max}$

3 Starting  $T_J = 25^\circ\text{C}$

**Electrical Characteristics** ( $T_J = +25^\circ\text{C}$  unless otherwise specified)

**Typical Performance - Static**

Parameter	Symbol	Test Conditions	Value			Units
			Min	Typ	Max	
Drain-source breakdown voltage	$BV_{DS}$	$V_{GS}=0V, I_D=1mA$	650			V
Total drain leakage current	$I_{DSS}$	$V_{DS}=650V,$ $V_{GS}=0V, T_J=25^\circ\text{C}$		6	150	$\mu\text{A}$
		$V_{DS}=650V,$ $V_{GS}=0V, T_J=175^\circ\text{C}$		30		
Total gate leakage current	$I_{GSS}$	$V_{DS}=0V, T_J=25^\circ\text{C},$ $V_{GS}=-20V / +20V$		6	$\pm 20$	$\mu\text{A}$
Drain-source on-resistance	$R_{DS(on)}$	$V_{GS}=12V, I_D=50A,$ $T_J=25^\circ\text{C}$		27	35	$\text{m}\Omega$
		$V_{GS}=12V, I_D=50A,$ $T_J=175^\circ\text{C}$		43		
Gate threshold voltage	$V_{G(th)}$	$V_{DS}=5V, I_D=10mA$	4	5	6	V
Gate resistance	$R_G$	$f=1\text{MHz}, \text{open drain}$		4.5		$\Omega$

**Typical Performance - Reverse Diode**

Parameter	Symbol	Test Conditions	Value			Units
			Min	Typ	Max	
Diode continuous forward current <sup>1</sup>	$I_S$	$T_C=25^\circ\text{C}$			85	A
Diode pulse current <sup>2</sup>	$I_{S,pulse}$	$T_C=25^\circ\text{C}$			230	A
Forward voltage	$V_{FSD}$	$V_{GS}=0V, I_F=20A,$ $T_J=25^\circ\text{C}$		1.3	1.4	V
		$V_{GS}=0V, I_F=20A,$ $T_J=175^\circ\text{C}$		1.35		
Reverse recovery charge	$Q_{rr}$	$V_R=400V, I_F=50A,$ $V_{GS}=0V, R_{G\_EXT}=20\Omega$		400		nC
Reverse recovery time	$t_{rr}$	$di/dt=1550A/\mu\text{s},$ $T_J=150^\circ\text{C}$		33		ns

**Typical Performance - Dynamic**

Parameter	symbol	Test Conditions	Value			Units
			Min	Typ	Max	
Input capacitance	$C_{iss}$	$V_{DS}=100V,$ $V_{GS}=0V,$ $f=100kHz$		1500		pF
Output capacitance	$C_{oss}$			320		
Reverse transfer capacitance	$C_{rss}$			2.3		
Effective output capacitance, energy related	$C_{oss(er)}$	$V_{DS}=0V$ to 400V, $V_{GS}=0V$		230		pF
Effective output capacitance, time related	$C_{oss(tr)}$	$V_{DS}=0V$ to 400V, $V_{GS}=0V$		520		pF
$C_{oss}$ stored energy	$E_{oss}$	$V_{DS}=400V, V_{GS}=0V$		18.5		μJ
Total gate charge	$Q_G$	$V_{DS}=400V, I_D=50A,$ $V_{GS}=-5V$ to 15V		51		nC
Gate-drain charge	$Q_{GD}$			11		
Gate-source charge	$Q_{GS}$			19		
Turn-on delay time	$t_{d(on)}$	$V_{DS}=400V, I_D=50A,$ Gate Driver=-5V to +15V, Turn-on $R_{G,EXT}=1\Omega,$ Turn-off $R_{G,EXT}=20\Omega$ Inductive Load, FWD: UJ3D06530TS $T_J=150^\circ C$		44		ns
Rise time	$t_r$			26		
Turn-off delay time	$t_{d(off)}$			63		
Fall time	$t_f$			17		
Turn-on energy	$E_{ON}$			657		μJ
Turn-off energy	$E_{OFF}$			330		
Total switching energy	$E_{TOTAL}$			987		

**Thermal Characteristics**

Parameter	symbol	Test Conditions	Value			Units
			Min	Typ	Max	
Thermal resistance, junction-to-case	$R_{\theta JC}$			0.26	0.34	°C/W

Typical Performance Diagrams

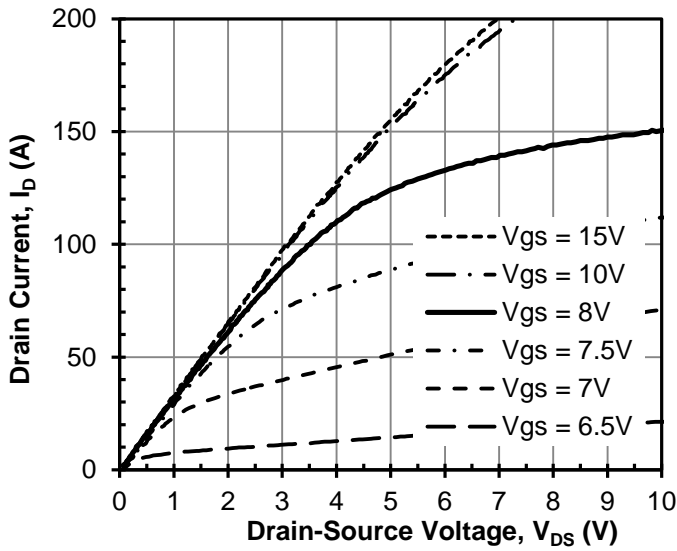

Figure 1 Typical output characteristics at  $T_J = -55^\circ\text{C}$ ,  $t_p < 250 \mu\text{s}$

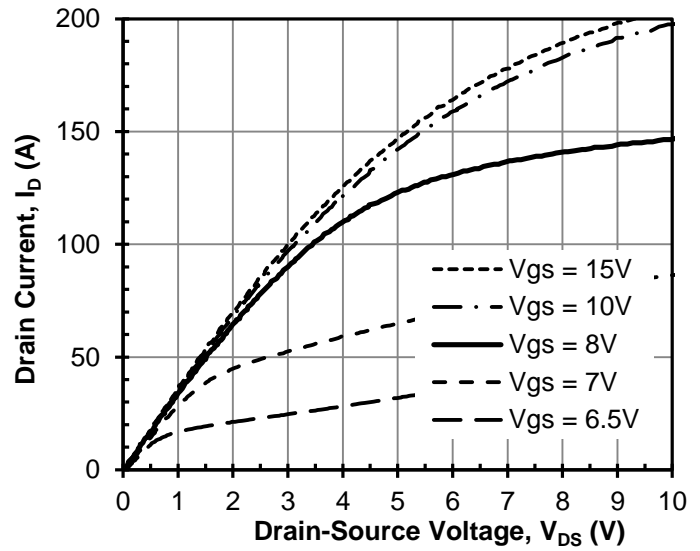

Figure 2 Typical output characteristics at  $T_J = 25^\circ\text{C}$ ,  $t_p < 250 \mu\text{s}$

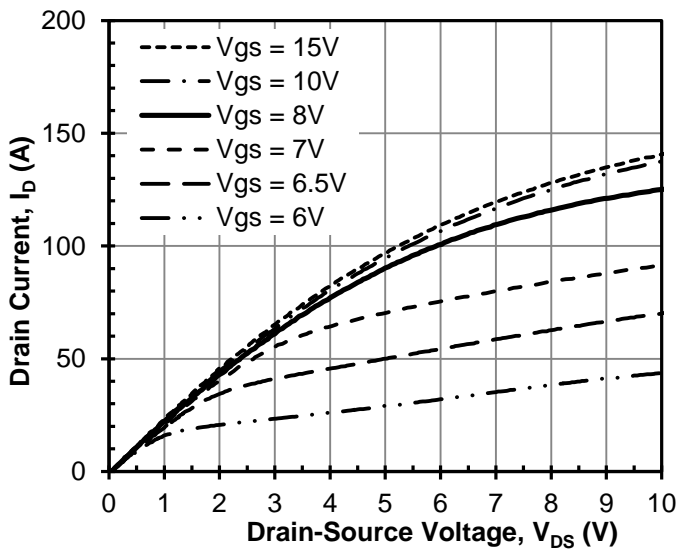

Figure 3 Typical output characteristics at  $T_J = 175^\circ\text{C}$ ,  $t_p < 250 \mu\text{s}$

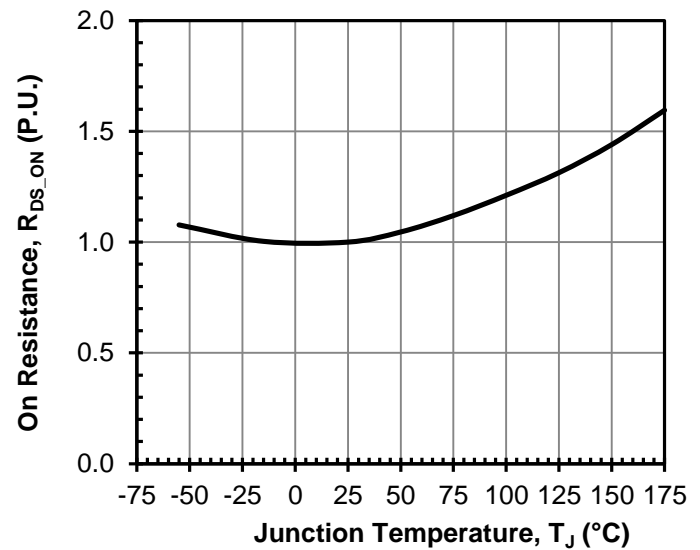

Figure 4 Normalized on-resistance vs. temperature at  $V_{GS} = 12\text{V}$  and  $I_D = 50\text{A}$

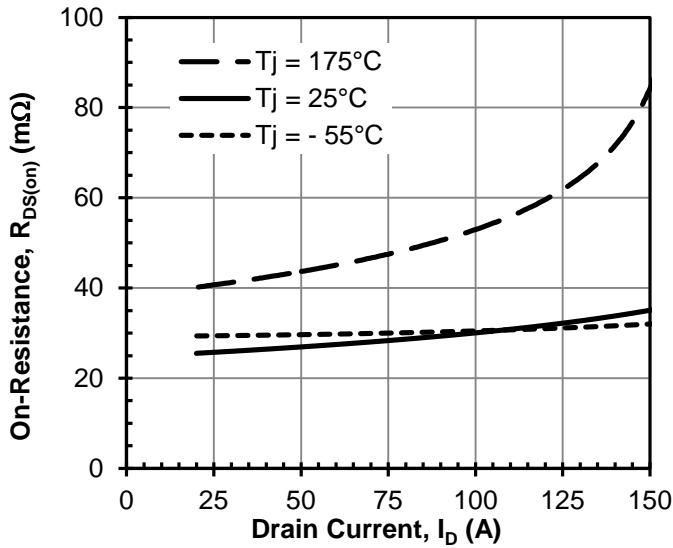

Figure 5 Typical drain-source on-resistance at  $V_{GS} = 12V$

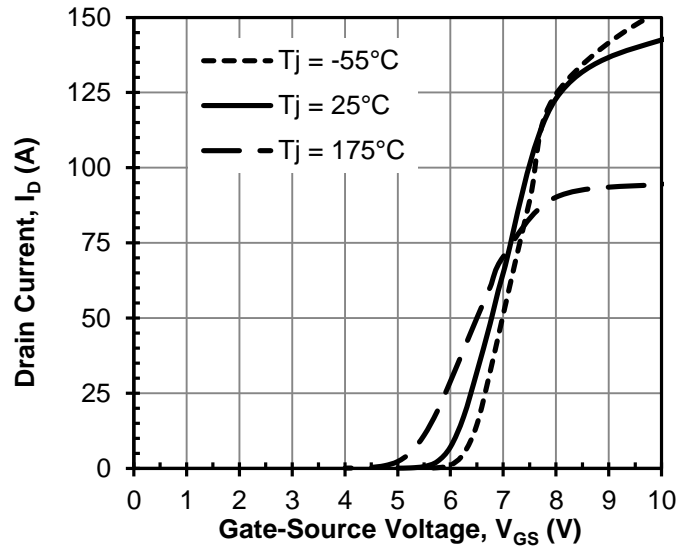

Figure 6 Typical transfer characteristics at  $V_{DS} = 5V$

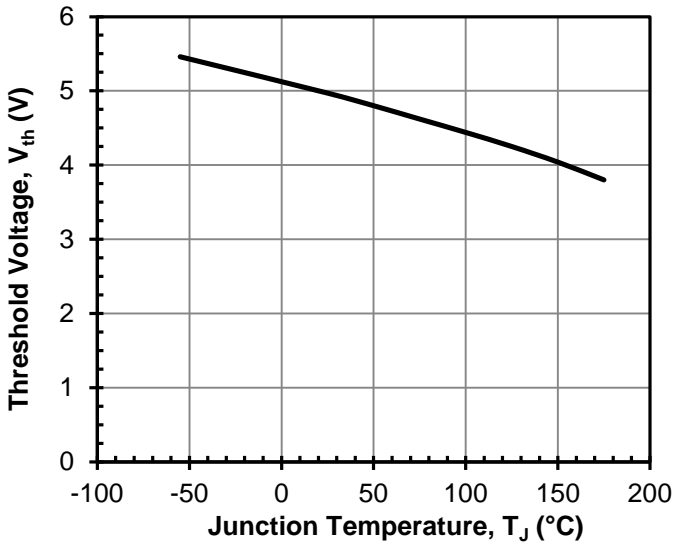

Figure 7 Threshold voltage vs.  $T_J$  at  $V_{DS} = 5V$  and  $I_D = 10mA$

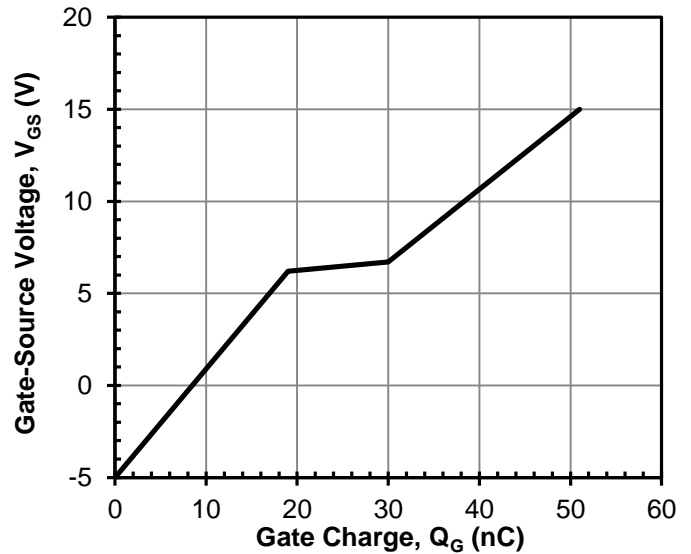

Figure 8 Typical gate charge at  $V_{DS} = 400V$  and  $I_D = 50A$

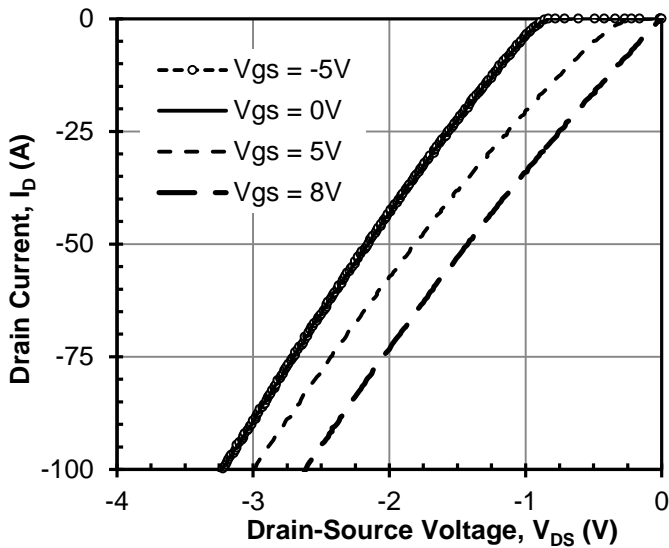

Figure 9 3rd quadrant characteristics at  $T_J = -55^\circ\text{C}$

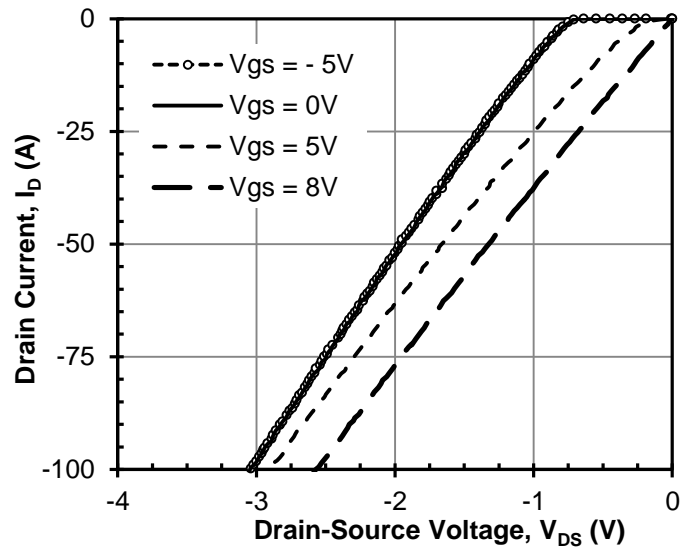

Figure 10 3rd quadrant characteristics at  $T_J = 25^\circ\text{C}$

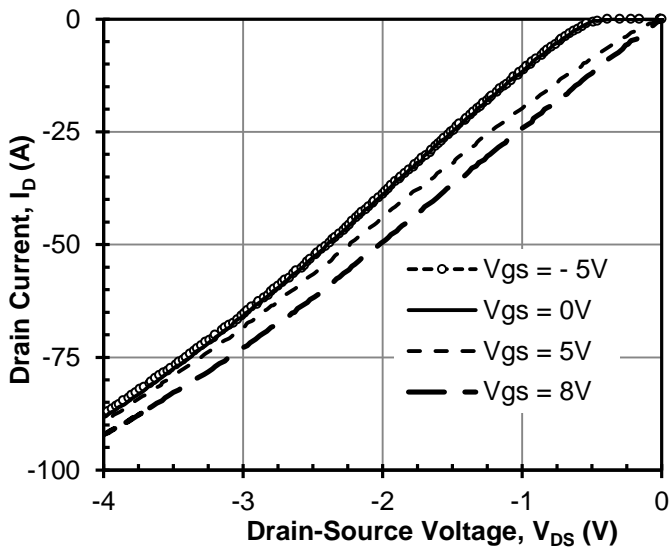

Figure 11 3rd quadrant characteristics at  $T_J = 175^\circ\text{C}$

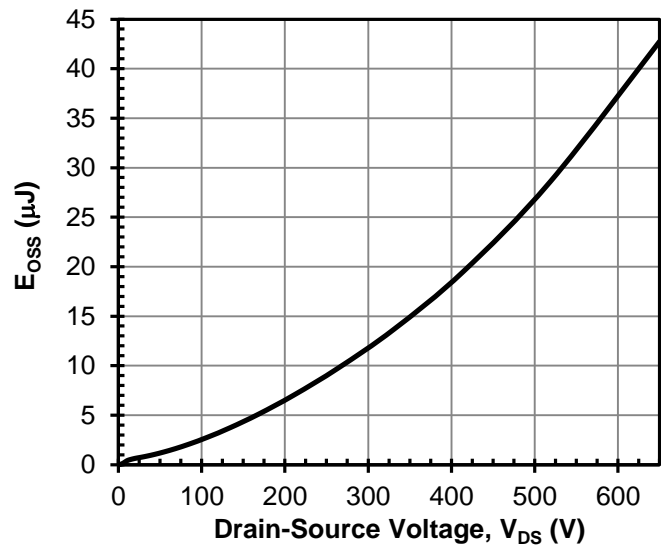

Figure 12 Typical stored energy in  $C_{OSS}$  at  $V_{GS} = 0\text{V}$

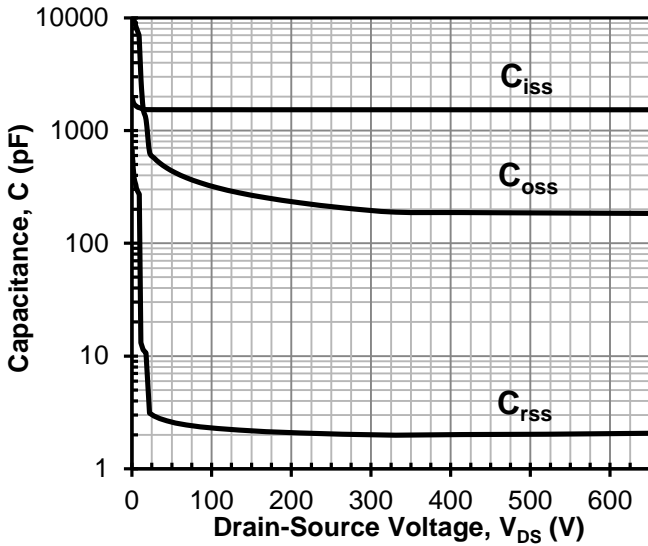

Figure 13 Typical capacitances at 100kHz and  $V_{GS} = 0V$

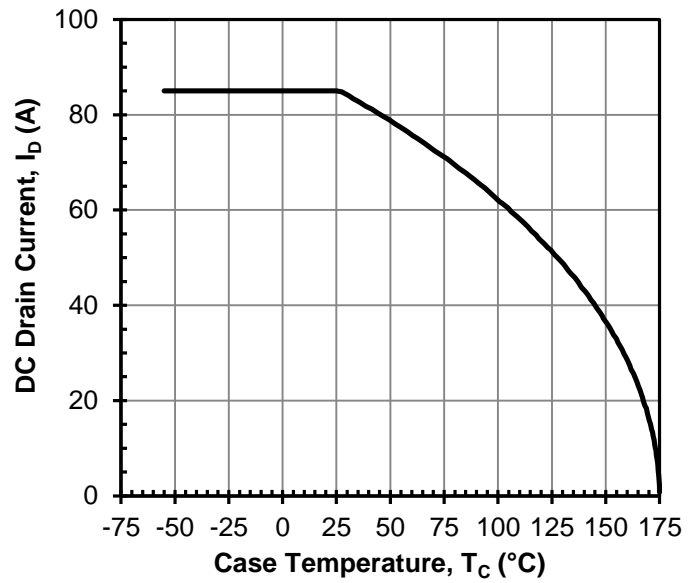

Figure 14 DC drain current derating

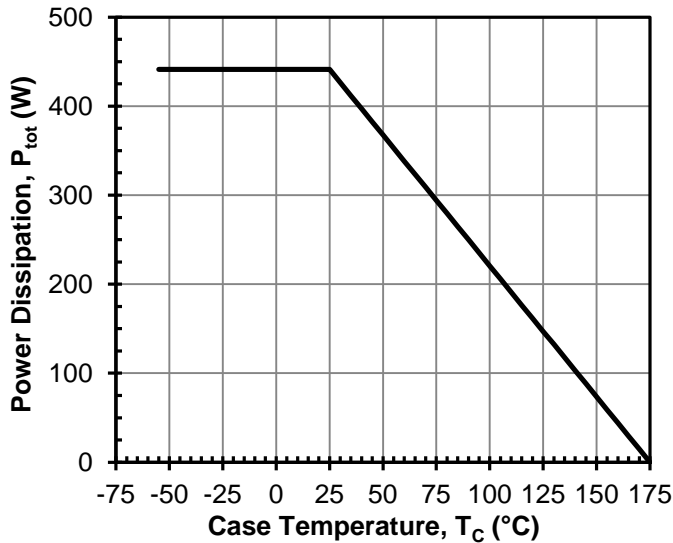

Figure 15 Total power dissipation

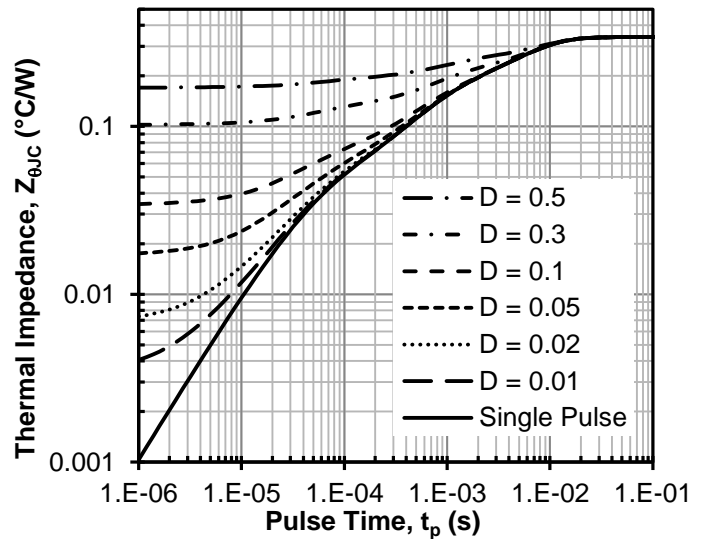

Figure 16 Maximum transient thermal impedance

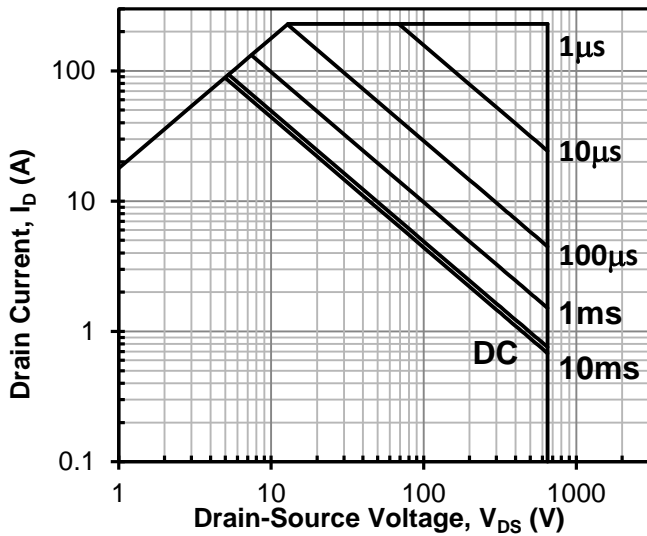

Figure 17 Safe operation area  
 $T_c = 25^\circ\text{C}$ ,  $D = 0$ , Parameter  $t_p$

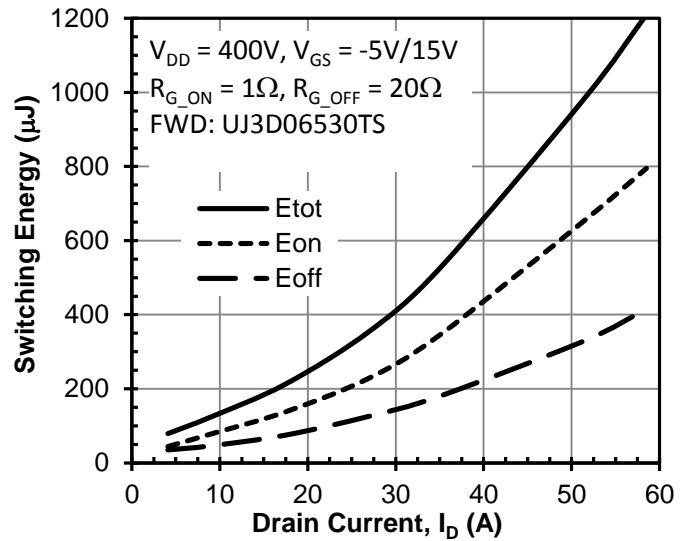

Figure 18 Clamped inductive switching energy vs. drain current at  $T_J = 150^\circ\text{C}$

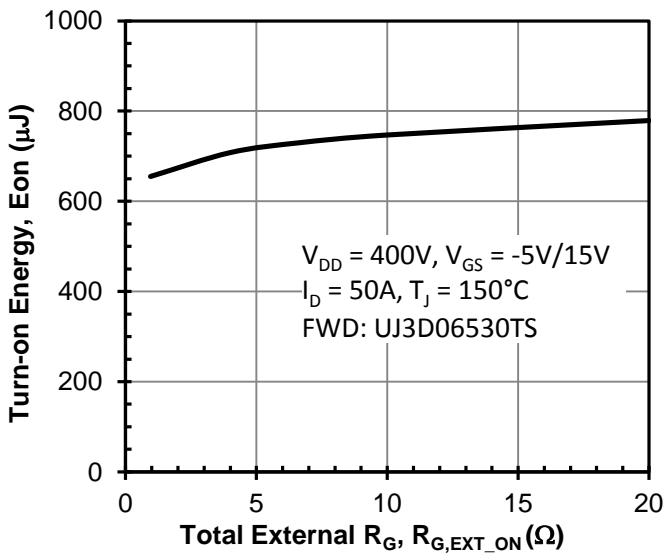

Figure 19 Clamped inductive switching turn-on energy vs.  $R_{G\_EXT\_ON}$

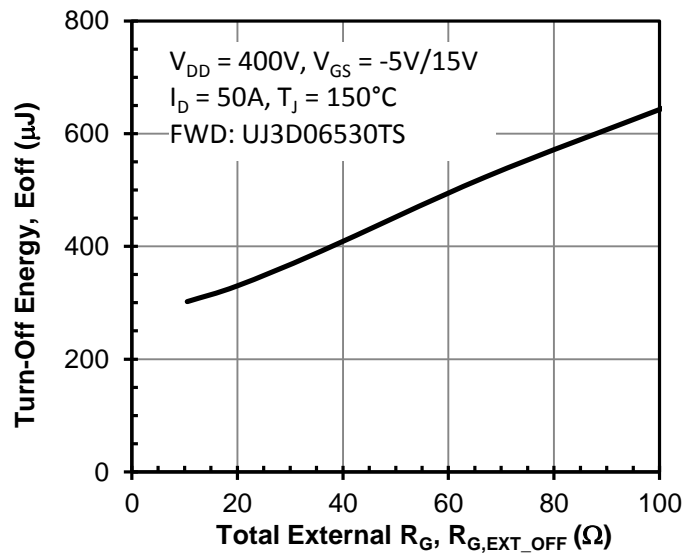

Figure 20 Clamped inductive switching turn-off energy vs.  $R_{G\_EXT\_OFF}$



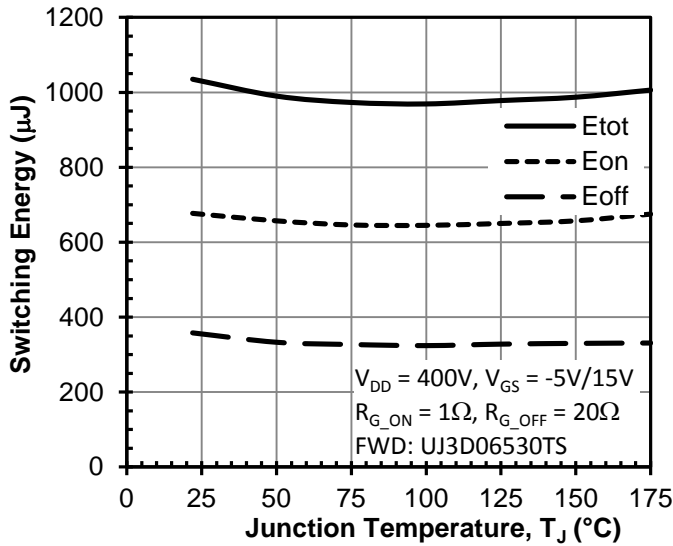

Figure 21 Clamped inductive switching energy vs. junction temperature at  $I_D = 50A$

## Applications Information

SiC cascodes are enhancement-mode power switches formed by a high-voltage SiC depletion-mode JFET and a low-voltage silicon MOSFET connected in series. The silicon MOSFET serves as the control unit while the SiC JFET provides high voltage blocking in the off state. This combination of devices in a single package provides compatibility with standard gate drivers and offers superior performance in terms of low on-resistance ( $R_{DS(on)}$ ), output capacitance ( $C_{oss}$ ), gate charge ( $Q_g$ ), and reverse recovery charge ( $Q_{rr}$ ) leading to low conduction and switching losses. The SiC cascodes also provide excellent reverse conduction capability eliminating the need for an external anti-parallel diode.

Like other high performance power switches, proper PCB layout design to minimize circuit parasitics is strongly recommended due to the high  $dv/dt$  and  $di/dt$  rates. An external gate resistor is recommended when the cascode is working in the diode mode in order to achieve the optimum reverse recovery performance. For more information on cascode operation, see [www.unitedsic.com](http://www.unitedsic.com).

## Disclaimer

United Silicon Carbide, Inc. reserves the right to change or modify any of the products and their inherent physical and technical specifications without prior notice. United Silicon Carbide, Inc. assumes no responsibility or liability for any errors or inaccuracies within.

Information on all products and contained herein is intended for description only. No license, express or implied, to any intellectual property rights is granted within this document.

United Silicon Carbide, Inc. assumes no liability whatsoever relating to the choice, selection or use of the United Silicon Carbide, Inc. products and services described herein.