

Description

United Silicon Carbide's cascode products co-package its high-performance G3 SiC JFETs with a cascode optimized MOSFET to produce the only standard gate drive SiC device in the market today. This series exhibits ultra-low gate charge, but also the best reverse recovery characteristics of any device of similar ratings. These devices are excellent for switching inductive loads, and any application requiring standard gate drive.

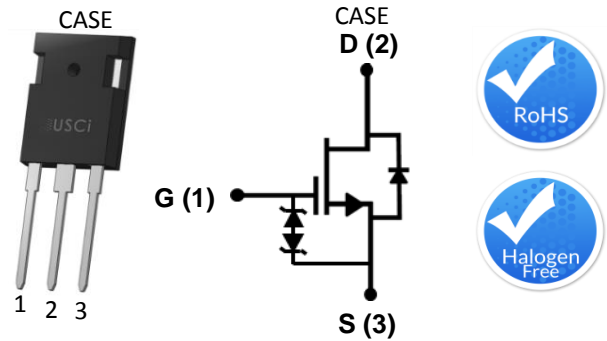

Part Number	Package	Marking
UJ3C065080K3S	TO-247-3L	UJ3C065080K3S

Features

- ◆ Typical on-resistance $R_{DS(on),typ}$ of 80mΩ
- ◆ Maximum operating temperature of 175°C
- ◆ Excellent reverse recovery
- ◆ Low gate charge
- ◆ Low intrinsic capacitance
- ◆ ESD protected, HBM class 2

Typical Applications

- ◆ EV charging
- ◆ PV inverters
- ◆ Switch mode power supplies
- ◆ Power factor correction modules
- ◆ Motor drives
- ◆ Induction heating

Maximum Ratings

Parameter	Symbol	Test Conditions	Value	Units
Drain-source voltage	V_{DS}		650	V
Gate-source voltage	V_{GS}	DC	-25 to +25	V
Continuous drain current ¹	I_D	$T_C=25^\circ\text{C}$	31	A
		$T_C=100^\circ\text{C}$	23	A
Pulsed drain current ²	I_{DM}	$T_C=25^\circ\text{C}$	65	A
Single pulsed avalanche energy ³	E_{AS}	$L=15\text{mH}$, $I_{AS}=2.1\text{A}$	33	mJ
Power dissipation	P_{tot}	$T_C=25^\circ\text{C}$	190	W
Maximum junction temperature	$T_{J,max}$		175	°C
Operating and storage temperature	T_J , T_{STG}		-55 to 175	°C
Max. lead temperature for soldering, 1/8" from case for 5 seconds	T_L		250	°C

1 Limited by $T_{J,max}$

2 Pulse width t_p limited by $T_{J,max}$

3 Starting $T_J = 25^\circ\text{C}$

Electrical Characteristics ($T_J = +25^\circ\text{C}$ unless otherwise specified)

Typical Performance - Static

Parameter	Symbol	Test Conditions	Value			Units
			Min	Typ	Max	
Drain-source breakdown voltage	BV_{DS}	$V_{GS}=0V, I_D=1mA$	650			V
Total drain leakage current	I_{DSS}	$V_{DS}=650V,$ $V_{GS}=0V, T_J=25^\circ\text{C}$		6	100	μA
		$V_{DS}=650V,$ $V_{GS}=0V, T_J=175^\circ\text{C}$		40		
Total gate leakage current	I_{GSS}	$V_{DS}=0V, T_J=25^\circ\text{C},$ $V_{GS}=-20V / +20V$		6	± 20	μA
Drain-source on-resistance	$R_{DS(on)}$	$V_{GS}=12V, I_D=20A,$ $T_J=25^\circ\text{C}$		80	100	$\text{m}\Omega$
		$V_{GS}=12V, I_D=20A,$ $T_J=175^\circ\text{C}$		141		
Gate threshold voltage	$V_{G(th)}$	$V_{DS}=5V, I_D=10mA$	4	5	6	V
Gate resistance	R_G	$f=1\text{MHz}, \text{open drain}$		4.5		Ω

Typical Performance - Reverse Diode

Parameter	Symbol	Test Conditions	Value			Units
			Min	Typ	Max	
Diode continuous forward current ¹	I_S	$T_C=25^\circ\text{C}$			31	A
Diode pulse current ²	$I_{S,pulse}$	$T_C=25^\circ\text{C}$			65	A
Forward voltage	V_{FSD}	$V_{GS}=0V, I_F=10A,$ $T_J=25^\circ\text{C}$		1.5	2	V
		$V_{GS}=0V, I_F=10A,$ $T_J=175^\circ\text{C}$		1.75		
Reverse recovery charge	Q_{rr}	$V_R=400V, I_F=20A,$ $V_{GS}=0V, R_{G_EXT}=20\Omega$		111		nC
Reverse recovery time	t_{rr}	$di/dt=1600A/\mu\text{s},$ $T_J=150^\circ\text{C}$		16		ns

Typical Performance - Dynamic

Parameter	symbol	Test Conditions	Value			Units
			Min	Typ	Max	
Input capacitance	C_{iss}	$V_{DS}=100V,$ $V_{GS}=0V,$ $f=100kHz$		1500		pF
Output capacitance	C_{oss}			104		
Reverse transfer capacitance	C_{rss}			2.6		
Effective output capacitance, energy related	$C_{oss(er)}$	$V_{DS}=0V$ to 400V, $V_{GS}=0V$		77		pF
Effective output capacitance, time related	$C_{oss(tr)}$	$V_{DS}=0V$ to 400V, $V_{GS}=0V$		176		pF
C_{oss} stored energy	E_{oss}	$V_{DS}=400V, V_{GS}=0V$		6.2		μJ
Total gate charge	Q_G	$V_{DS}=400V, I_D=20A,$ $V_{GS}=-5V$ to 15V		51		nC
Gate-drain charge	Q_{GD}			11		
Gate-source charge	Q_{GS}			19		
Turn-on delay time	$t_{d(on)}$	$V_{DS}=400V, I_D=20A,$ Gate Driver=-5V to +15V, Turn-on $R_{G,EXT}=1\Omega,$ Turn-off $R_{G,EXT}=20\Omega$ Inductive Load, FWD: UJ3D06510TS $T_J=150^\circ C$		18		ns
Rise time	t_r			13		
Turn-off delay time	$t_{d(off)}$			59		
Fall time	t_f			11		
Turn-on energy	E_{ON}			85		μJ
Turn-off energy	E_{OFF}			62		
Total switching energy	E_{TOTAL}			147		

Thermal Characteristics

Parameter	symbol	Test Conditions	Value			Units
			Min	Typ	Max	
Thermal resistance, junction-to-case	$R_{\theta JC}$			0.61	0.79	°C/W

Typical Performance Diagrams

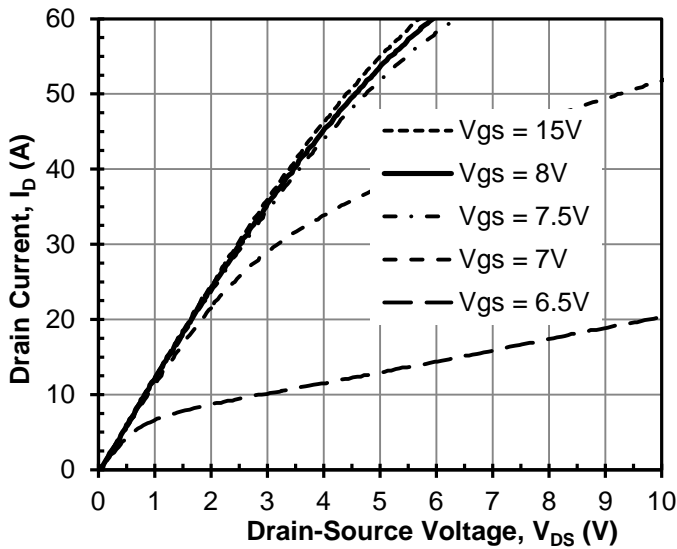

Figure 1 Typical output characteristics at $T_J = -55^\circ\text{C}$, $t_p < 250 \mu\text{s}$

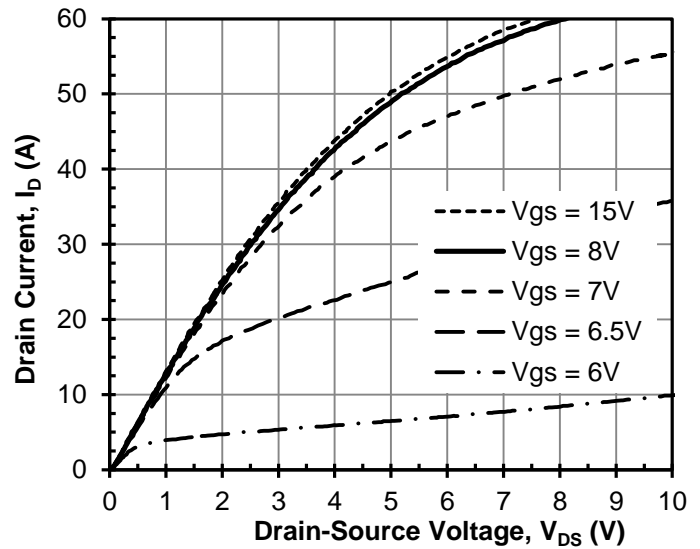

Figure 2 Typical output characteristics at $T_J = 25^\circ\text{C}$, $t_p < 250 \mu\text{s}$

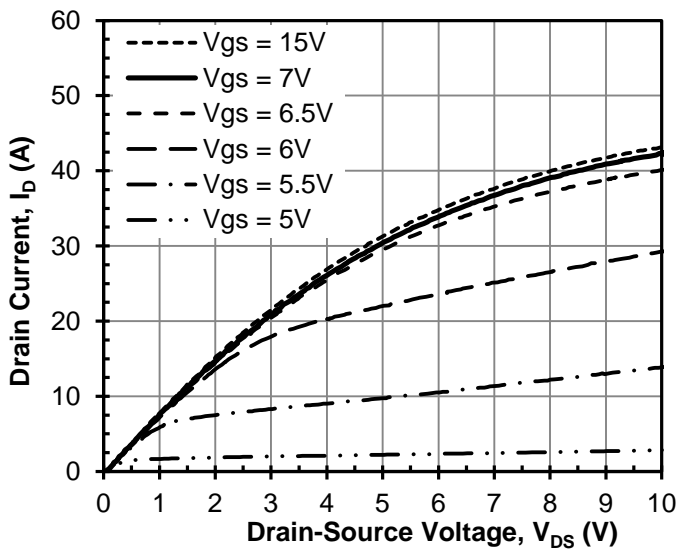

Figure 3 Typical output characteristics at $T_J = 175^\circ\text{C}$, $t_p < 250 \mu\text{s}$

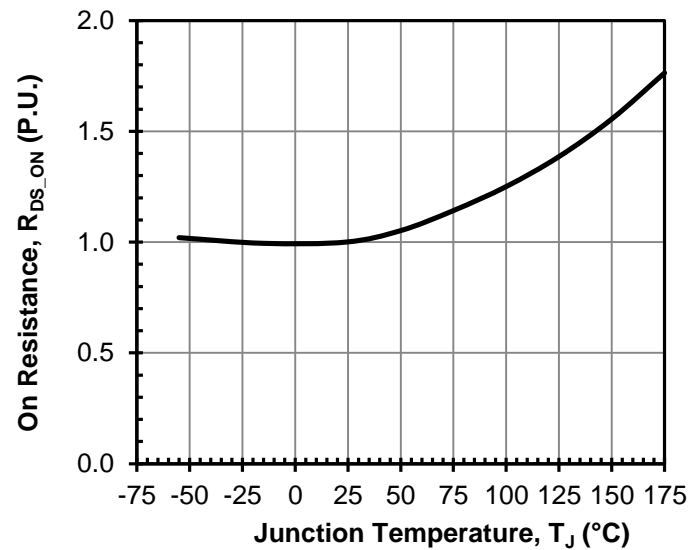

Figure 4 Normalized on-resistance vs. temperature at $V_{GS} = 12\text{V}$ and $I_D = 20\text{A}$

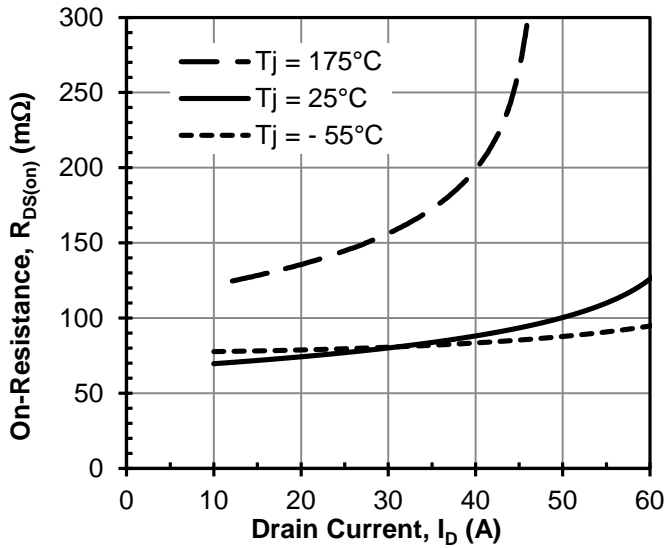

Figure 5 Typical drain-source on-resistance at $V_{GS} = 12V$

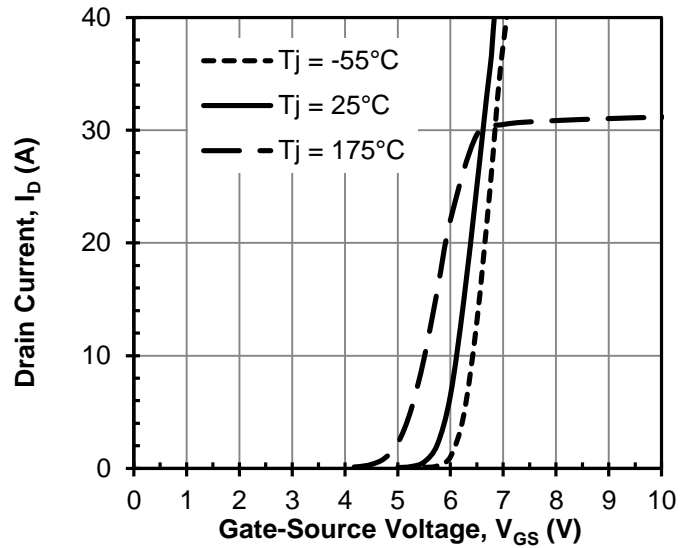

Figure 6 Typical transfer characteristics at $V_{DS} = 5V$

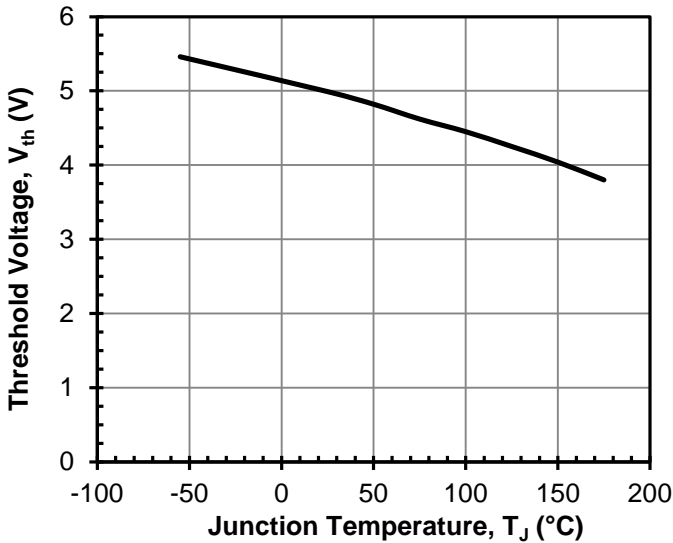

Figure 7 Threshold voltage vs. T_J at $V_{DS} = 5V$ and $I_D = 10mA$

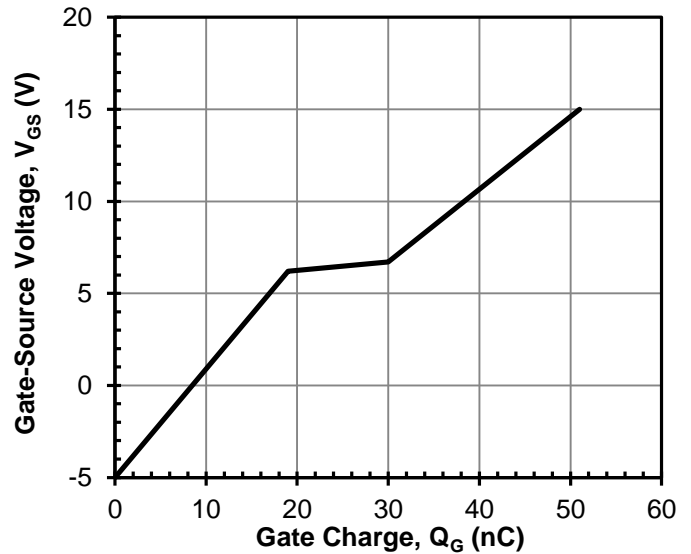

Figure 8 Typical gate charge at $V_{DS} = 400V$ and $I_D = 20A$

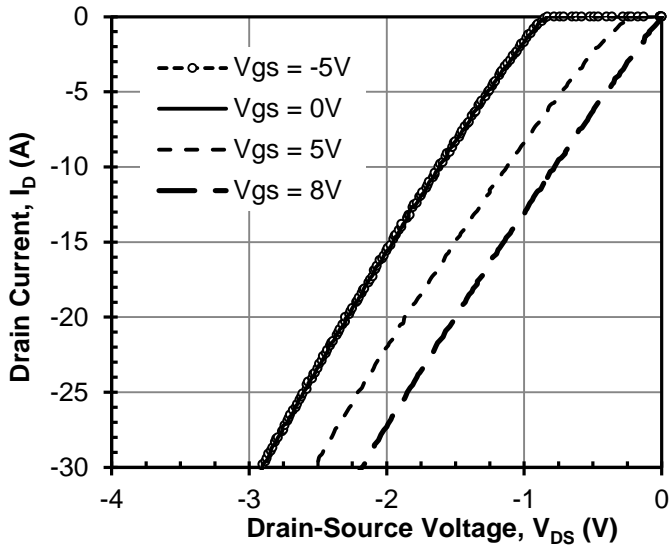

Figure 9 3rd quadrant characteristics at $T_J = -55^\circ\text{C}$

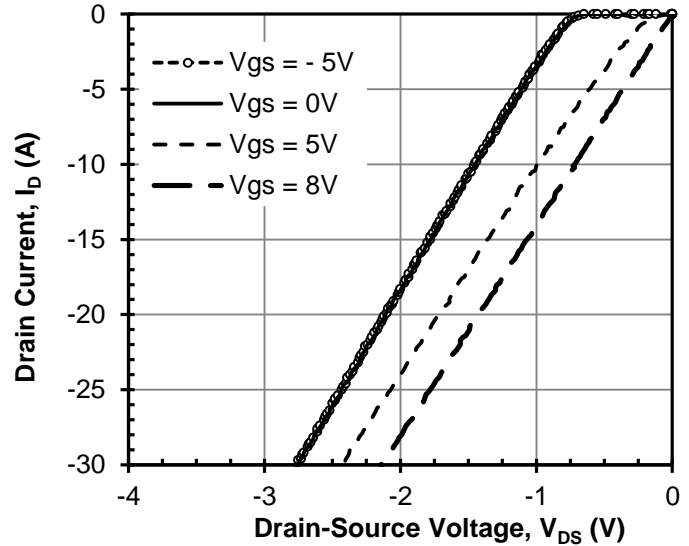

Figure 10 3rd quadrant characteristics at $T_J = 25^\circ\text{C}$

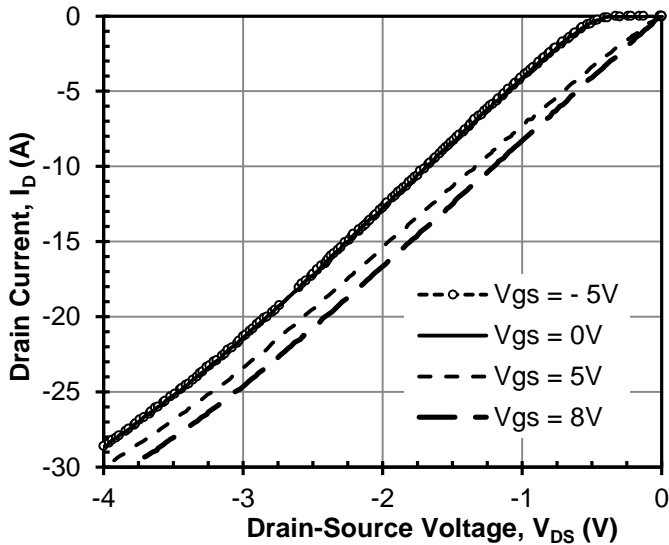

Figure 11 3rd quadrant characteristics at $T_J = 175^\circ\text{C}$

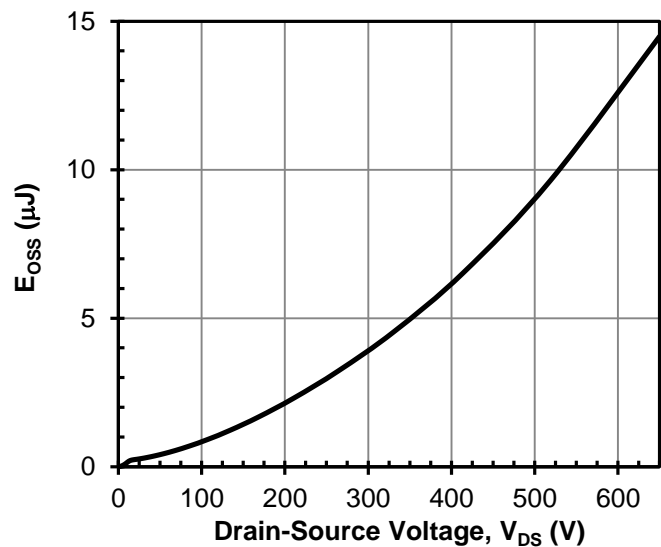

Figure 12 Typical stored energy in C_{OSS} at $V_{GS} = 0\text{V}$

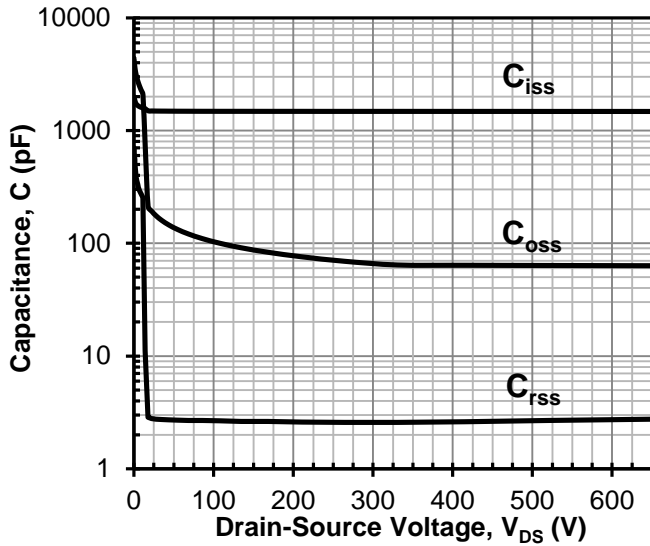

Figure 13 Typical capacitances at 100kHz and $V_{GS} = 0V$

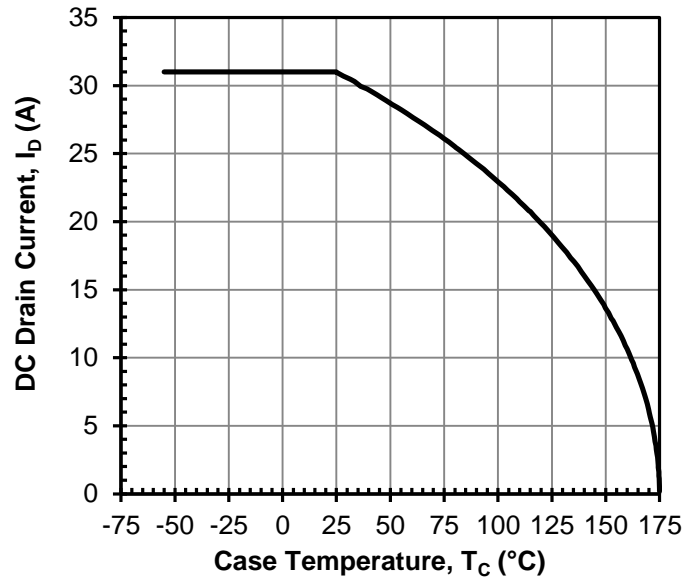

Figure 14 DC drain current derating

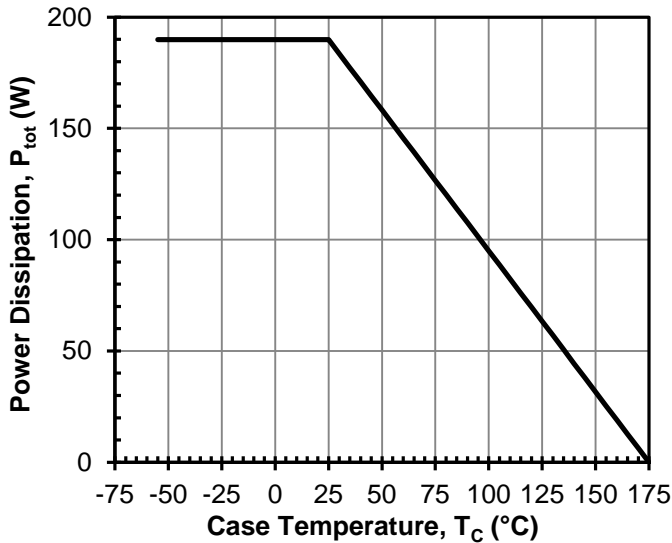

Figure 15 Total power dissipation

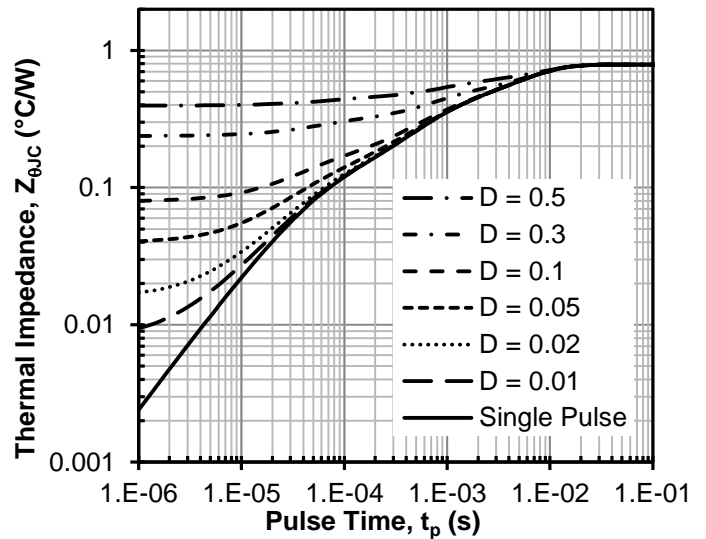

Figure 16 Maximum transient thermal impedance

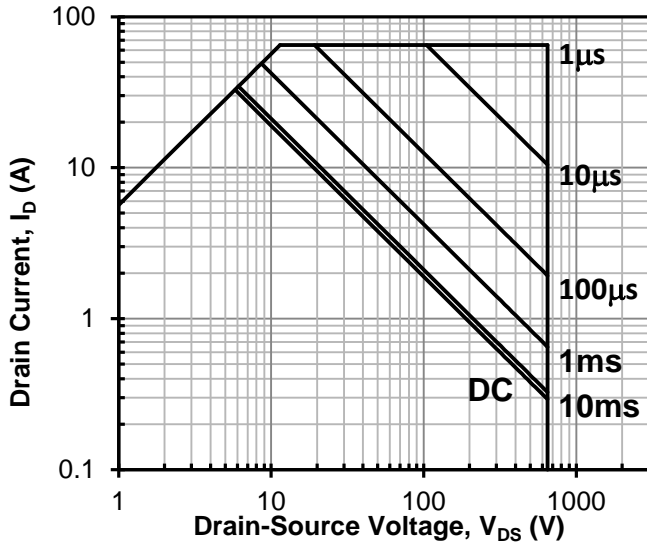

Figure 17 Safe operation area
 $T_c = 25^\circ\text{C}$, $D = 0$, Parameter t_p

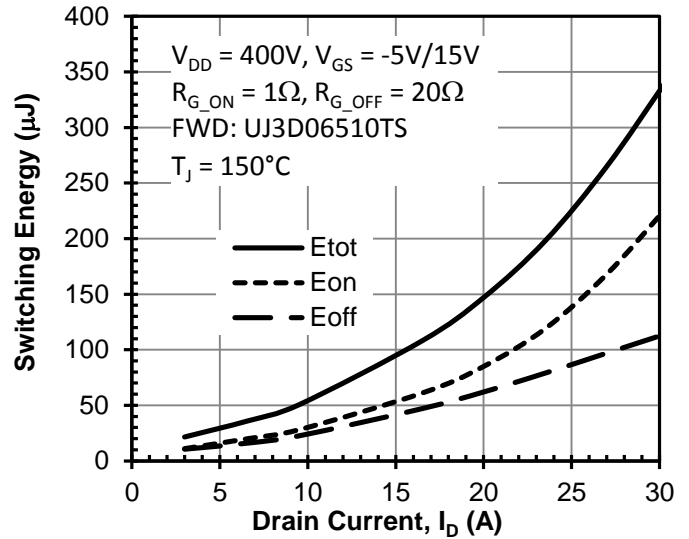

Figure 18 Clamped inductive switching energy vs. drain current at $T_J = 150^\circ\text{C}$

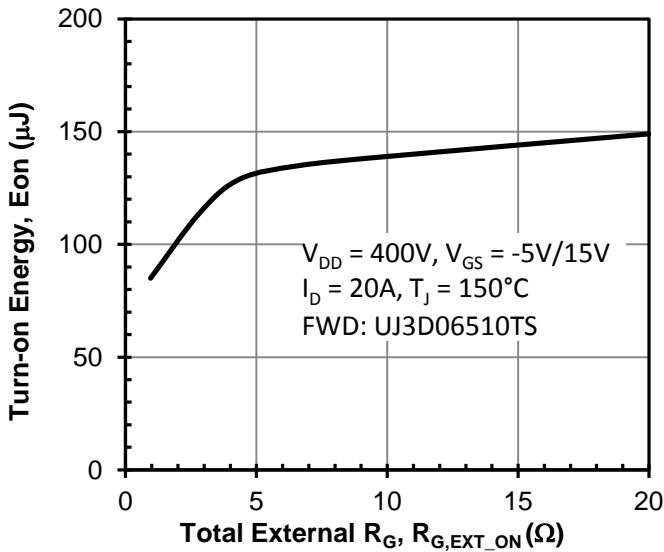

Figure 19 Clamped inductive switching turn-on energy vs. $R_{G_EXT_ON}$

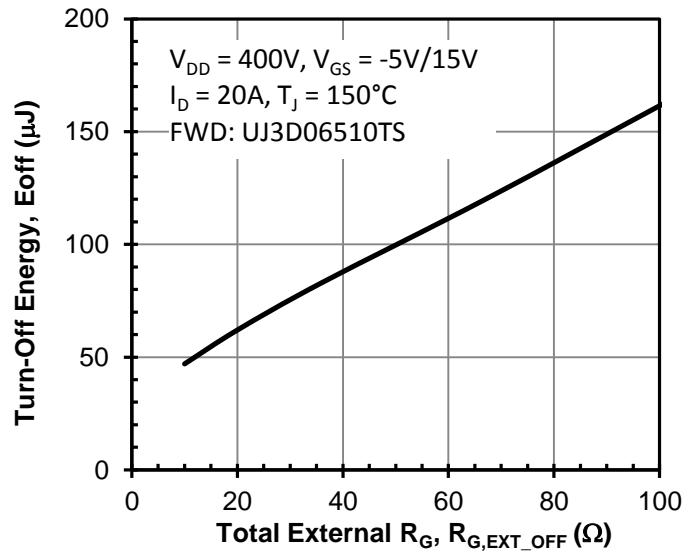

Figure 20 Clamped inductive switching turn-off energy vs. $R_{G_EXT_OFF}$

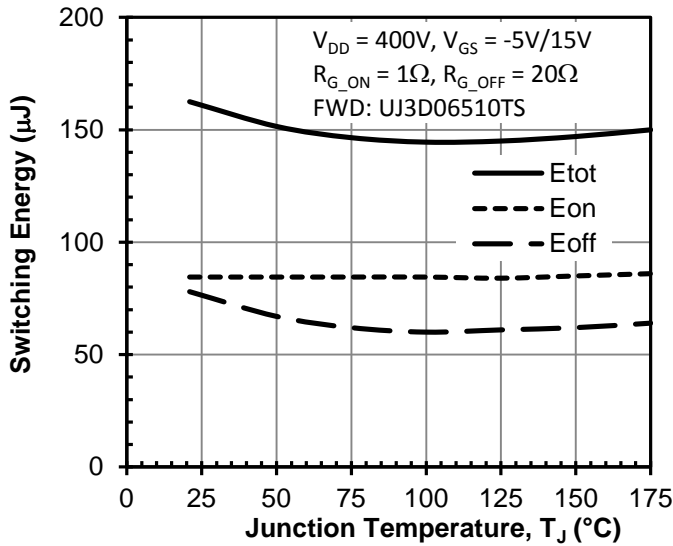

Figure 21 Clamped inductive switching energy vs. junction temperature at $I_D = 20A$

Applications Information

SiC cascodes are enhancement-mode power switches formed by a high-voltage SiC depletion-mode JFET and a low-voltage silicon MOSFET connected in series. The silicon MOSFET serves as the control unit while the SiC JFET provides high voltage blocking in the off state. This combination of devices in a single package provides compatibility with standard gate drivers and offers superior performance in terms of low on-resistance ($R_{DS(on)}$), output capacitance (C_{oss}), gate charge (Q_g), and reverse recovery charge (Q_{rr}) leading to low conduction and switching losses. The SiC cascodes also provide excellent reverse conduction capability eliminating the need for an external anti-parallel diode.

Like other high performance power switches, proper PCB layout design to minimize circuit parasitics is strongly recommended due to the high dv/dt and di/dt rates. An external gate resistor is recommended when the cascode is working in the diode mode in order to achieve the optimum reverse recovery performance. For more information on cascode operation, see www.unitedsic.com.

Disclaimer

United Silicon Carbide, Inc. reserves the right to change or modify any of the products and their inherent physical and technical specifications without prior notice. United Silicon Carbide, Inc. assumes no responsibility or liability for any errors or inaccuracies within.

Information on all products and contained herein is intended for description only. No license, express or implied, to any intellectual property rights is granted within this document.

United Silicon Carbide, Inc. assumes no liability whatsoever relating to the choice, selection or use of the United Silicon Carbide, Inc. products and services described herein.